



川源(中国)机械有限公司  
GSD (China) Co., Ltd.

A wide-angle photograph of a large concrete dam with multiple spillways, situated on a river. The sky is clear and blue, and there are green trees in the foreground on the right side.

# SAF/SMF

## 轴、混流潜水电泵

**SAF/SMF submersible electric pump**

# SAF/SMF 轴、混流潜水电泵

## SAF/SMF submersible electric pump



### 特点

SAF型轴流潜水电泵和SMF型混流潜水电泵是传统的轴流泵和混流泵电动机机组的更新换代产品，驱动水泵的电动机是干式全封闭潜水三相异步电动机，该型潜水电泵可长期浸入水中运行，具有传统机组一系列无可比拟的优点。

- 由于电机与水泵构成一体，无须在安装现场进行耗工、耗时的电机、传动机构、水泵轴线对中的装配工序，现场安装方便、快速。
- 由于潜入水中运行，可以大大简化泵站的土工及建筑结构工程，减少安装面积，节约工程造价30%~40%。
- 噪声低，泵站内无高温，改善操作环境，可按要求建成全地下泵站，保持地面的环境风貌。
- 潜水电机采用双重或三重机械密封，F级（耐温155℃）绝缘，防护等级为IP68（IEC）。泵段采用全国统一设计的水力模型，可靠性高，且与传统水泵性能一致，便于用户选型。

### 用途

SAF、SMF两型潜水电泵，可供洪水排涝之用，也可用于工矿船坞、城市建设、供水工程、电站给排水之用。轴流潜水电泵适用于低扬程、大流量场合，混流潜水电泵效率高、汽蚀性能好，适用于水位变化较大及扬程要求较高的场合，输送介质为原水或轻度污水，其最高被输送液体温度40℃。

### Application

The two models SAF and SMF submersible electric pump can be used in irrigation and drainage of agricultural field, and can also be used in supply and sewerage water of factory, mine, dock, urban construction, water supply works and power station. The Axial-flow submersible electric pump applies to the condition of low-lift head, high flow-rate; while the mixed-flow submersible electric pump is very efficient with high performance of cavitation erosion. It is applicable for the occasion where the water level changes greatly and the requirement to the lift head is high. The conveyance medium is untreated water or lightly polluted water. The highest temperature of the conveyed liquid is 40℃.

### Features

The SAF model axial-flow submersible electric pump and SMF model mixed-flow submersible electric pump are the upgraded and updated product of electrical motor set of conventional axial-flow pump and mixed-flow pump, the electric motor of hydraulic pump is an asynchronous motor of dry totally-enclosed submersible which can be operated in water for long-term with the advantages the conventional motor series can't match.

- Because the electric motor is combined with the hydraulic pump, the assembly procedure is no longer necessary for lining up axis of electric motor, transmission mechanism and hydraulic pump on site, which costs labor and time. Now the installation on-the-spot becomes easy and fast.
- Because of its operation submerged into water, the electric pump can greatly simplify geotechnical engineering and building structure engineering of pump station, reduce erection space and save 30%~40% construction cost.
- Low noise, no high temperature in pump station, improving the operational environment and underground pump station can be built according to the requirement, as a result, the environmental scene on the ground can be maintained.
- Submersible electric pump has double and triple mechanical seal and F grade insulation (155℃ thermostable) with protection grade IP68(IEC). The pump has hydraulic model of nationwide unified design, which has high reliability and has the same performance of the conventional hydraulic pump so that the customer can select the model easily.



- 操作方便，易于实现遥控和自动控制。
- 采用该型潜水电泵是解决水位涨落大的沿江、湖泊地区建泵站，解决电机防洪问题较彻底的办法，且省去了机泵间的长轴和中间轴承，使机组运行更为稳定可靠。
- Convenient operation, and easy to realize remote control and automatic control.
- Adopting this type of submersible electric pump is the most thorough approach for building pump station along the river and lake area where the water level fluctuate greatly, as well as for resolving the problem of flood prevention of pump; moreover, the major shaft and intermediate shaft are not required any more, and the machine set can operate more steady and reliable.

## 型号说明 Type description

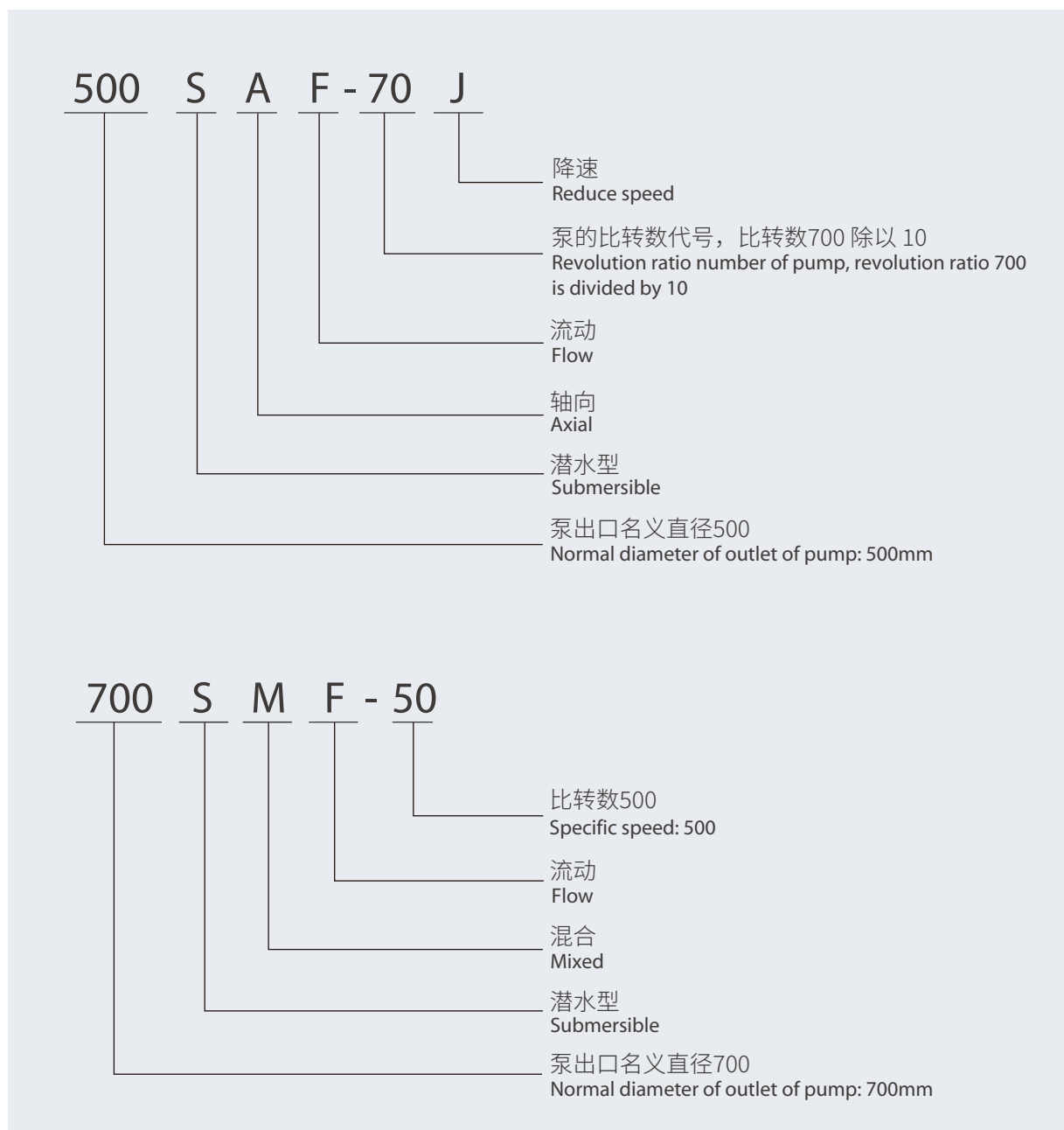

## 结构简图 (SAF型轴流潜水电泵) Structural diagram (SAF model axial-flow submersible electric pump)

NO.	名称	Name	材质		NO.	名称	Name	材质	
			GB	JIS				GB	JIS
1	动力电缆	Power cable	-	-	15	提升架	Lifting frame	06Cr19Ni10	SUS304
2	电缆压盖	Cable cover	HT200	FC200	16	控制电缆	Control cable	-	-
3	电缆固定套	Cable fixing sleeves	HT200	FC200	17	电缆压盖	Cable cover	06Cr19Ni10	SUS304
4	O型圈	O-ring	NBR	NBR	18	马达盖	Motor cover	HT200	FC200
5	接线盒	Junction box	HT200	FC200	19	接线柱	Terminal block	-	-
6	轴承	Bearing	-	-	20	主轴	Shaft	20Cr13	SUS420J1
7	马达本体	Motor casing	HT200	FC200	21	转子	Rotor	-	-
8	轴承压盖	Bearing cover	HT200	FC200	22	定子	Stator	-	-
9	中承座	Bracket	HT200	FC200	23	机械密封	Mechanical seal	C-SiC	C-SiC
10	机械密封	Mechanical seal	SiC-SiC	SiC-SiC	24	键	Key	20Cr13	SUS420J1
11	导叶体	Guide vane chamber	HT200	FC200	25	小圆螺母	Small round nuts	06Cr19Ni10	SUS304
12	叶轮毂	Impeller hub	HT200	FC200	26	叶片	Blade	ZG07Cr19Ni10	SUS304
13	叶轮螺母	Impeller nut	06Cr19Ni10	SUS304	27	进水喇叭口	Bell mouth	HT200	FC200
14	导水锥	Water guide cone	HT200	HT200					

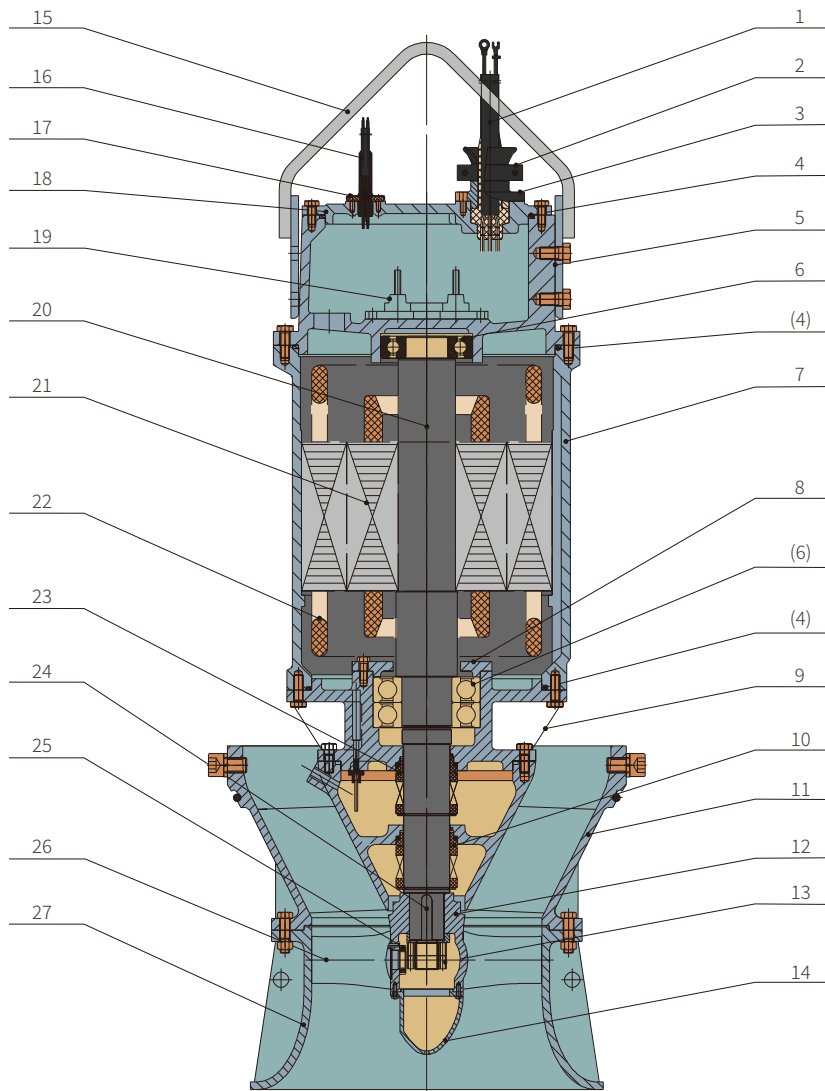

## 结构简图 (SMF型混流潜水电泵) Structural diagram (SMF model mixed-flow submersible electric pump)

NO.	名称 Name	材质 Material		NO.	名称 Name	材质 Material	
		GB	JIS			GB	JIS
1	动力电缆 Power cable	-	-	15	提升架 Lifting frame	06Cr19Ni10	SUS304
2	电缆压盖 Cable cover	HT200	FC200	16	控制电缆 Control cable	-	-
3	电缆固定套 Cable fixing sleeves	HT200	FC200	17	电缆压盖 Cable cover	06Cr19Ni10	SUS304
4	O型圈 O-ring	NBR	NBR	18	马达盖 Motor cover	HT200	FC200
5	接线盒 Junction box	HT200	FC200	19	接线柱 Terminal block	-	-
6	轴承 Bearing	-	-	20	主轴 Shaft	20Cr13	SUS420J1
7	马达本体 Motor casing	HT200	FC200	21	转子 Rotor	-	-
8	轴承压盖 Bearing cover	HT200	FC200	22	定子 Stator	-	-
9	中承座 Bracket	HT200	FC200	23	机械密封 Mechanical seal	C-SiC	C-SiC
10	机械密封 Mechanical seal	SiC-SiC	SiC-SiC	24	键 Key	20Cr13	SUS420J1
11	导叶体 Guide vane chamber	HT200	FC200	25	小圆螺母 Small round nuts	06Cr19Ni10	SUS304
12	叶轮毂 Impeller hub	HT200	FC200	26	叶片 Blade	ZG07Cr19Ni10	SUS304
13	叶轮螺母 Impeller nut	06Cr19Ni10	SUS304	27	进水喇叭口 Bell mouth	HT200	FC200
14	导水锥 Water guide cone	HT200	HT200				

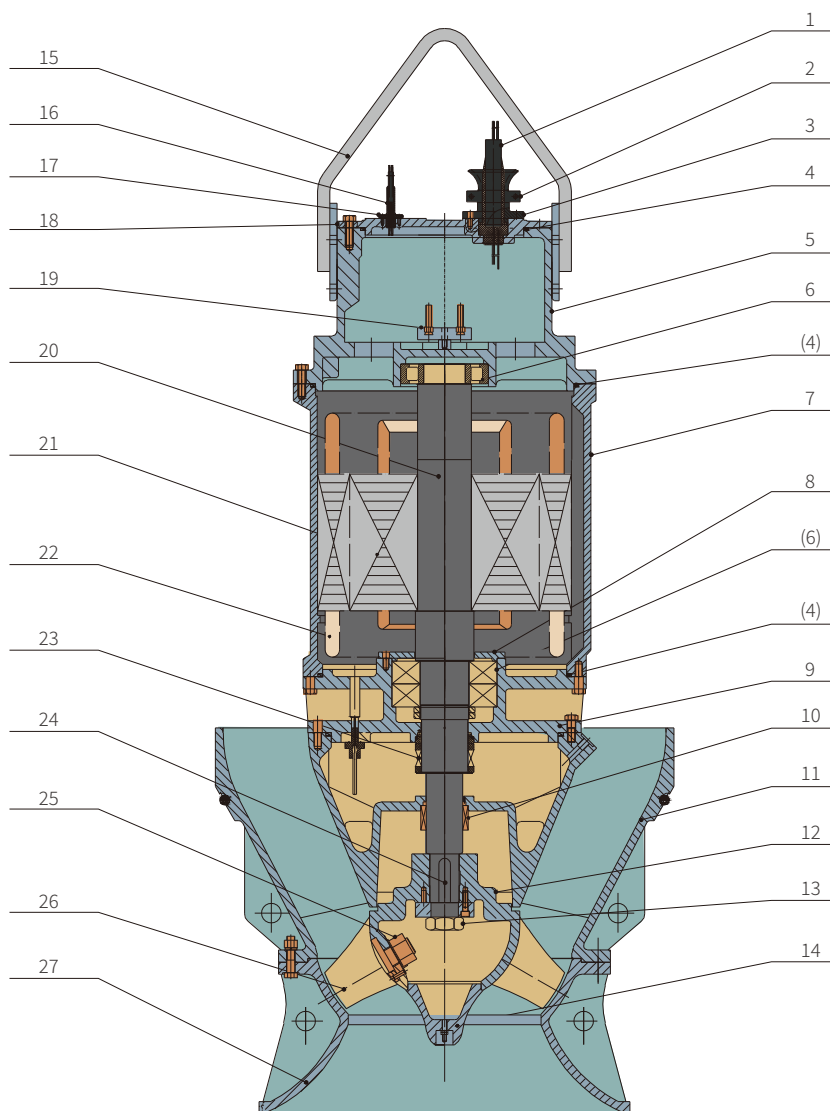

## 智能轴、混流潜水电泵结构图

### Intelligent SAF/SMF submersible electric pump structure

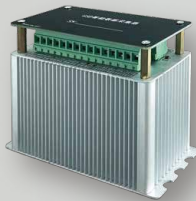

GSD3智能数据采集器 GSD3 Intelligent Data Collector

对内部监测项目信号进行收集打包传输，也可单独外接显示屏，现场直接显示水泵运转状态。

The internal monitoring signals are collected, packaged and transmitted and can also be connected to a separate external display to directly show the running status of the pump.



轴承测温 Heat detector in bearing

实现对轴承部位状态实时监测，故障预警，保护轴承及电机安全。

Real-time monitoring of bearing status and fault warning to protect bearing and motor safety.



绕组测温 Heat detector in stator

监控电机定子温度情况，防止电机温度过高。

Monitor the temperature of the motor stator to prevent the motor from overheating.

电动机 Motor

F级绝缘，防护等级IP68。

Class F insulation, protection class IP68.



电机内漏水保护 Leakage detector in motor

对电机腔内泄漏发出报警信号，对电机实施保护。

An alarm signal is sent to protect the motor if there is a leak in the motor cavity.



机械密封 Mechanical seal

双机械密封串联相互独立工作，为电动机提供双重保护。

Dual mechanical seals work independently in series to provide double protection for the motor.

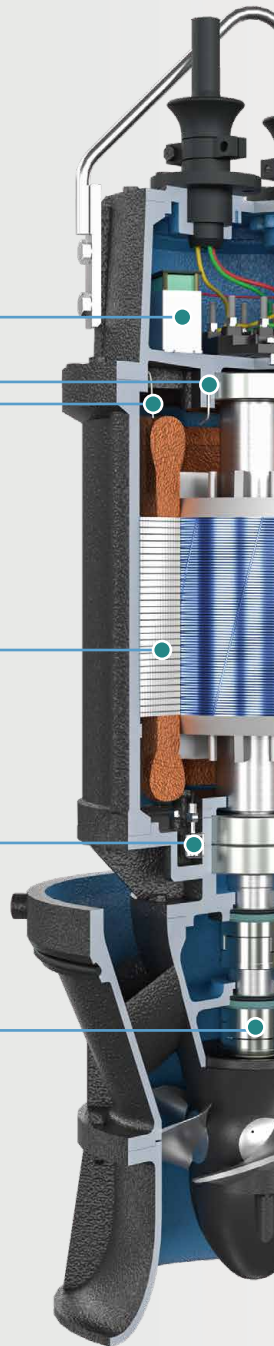



### 电缆 Cable

独特的电缆密封设计，排除了电缆漏水的隐患，能确保可靠的防水及运行安全。

The unique cablesealing design excludes the hidden danger of cable leakage and ensures reliable waterproofing and operational safety.

### 接线盒漏水保护 Leakage detector in junction box

对接线盒内泄漏发出报警信号，控制系统对泵实施保护。

An alarm signal is sent for leakage in the junction box, and the control system protects the pump.



### 振动 Vibration detector

使用振动规实时振动指标的监测，提供设备运行状态和专家诊断的专业数据。

Use vibration gauges to monitor vibration indicators in real time, providing equipment operating status and diagnostic professional data.

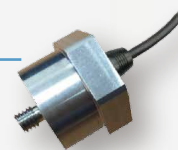

### 油室漏水保护 Leakage detector in oil chamber

检测因密封不良或机械密封损坏造成之泄漏，保护水泵运行安全。

Detect leakage caused by poor seal or mechanical seal damage to protect the safety of pump operation.



### 叶轮部件 Impeller components

轴流式叶轮，采用优秀的水力模型，效率高，性能优。

Axial flow impeller, using excellent hydraulic model, high efficiency and superior performance.



# 系统架构 System architecture

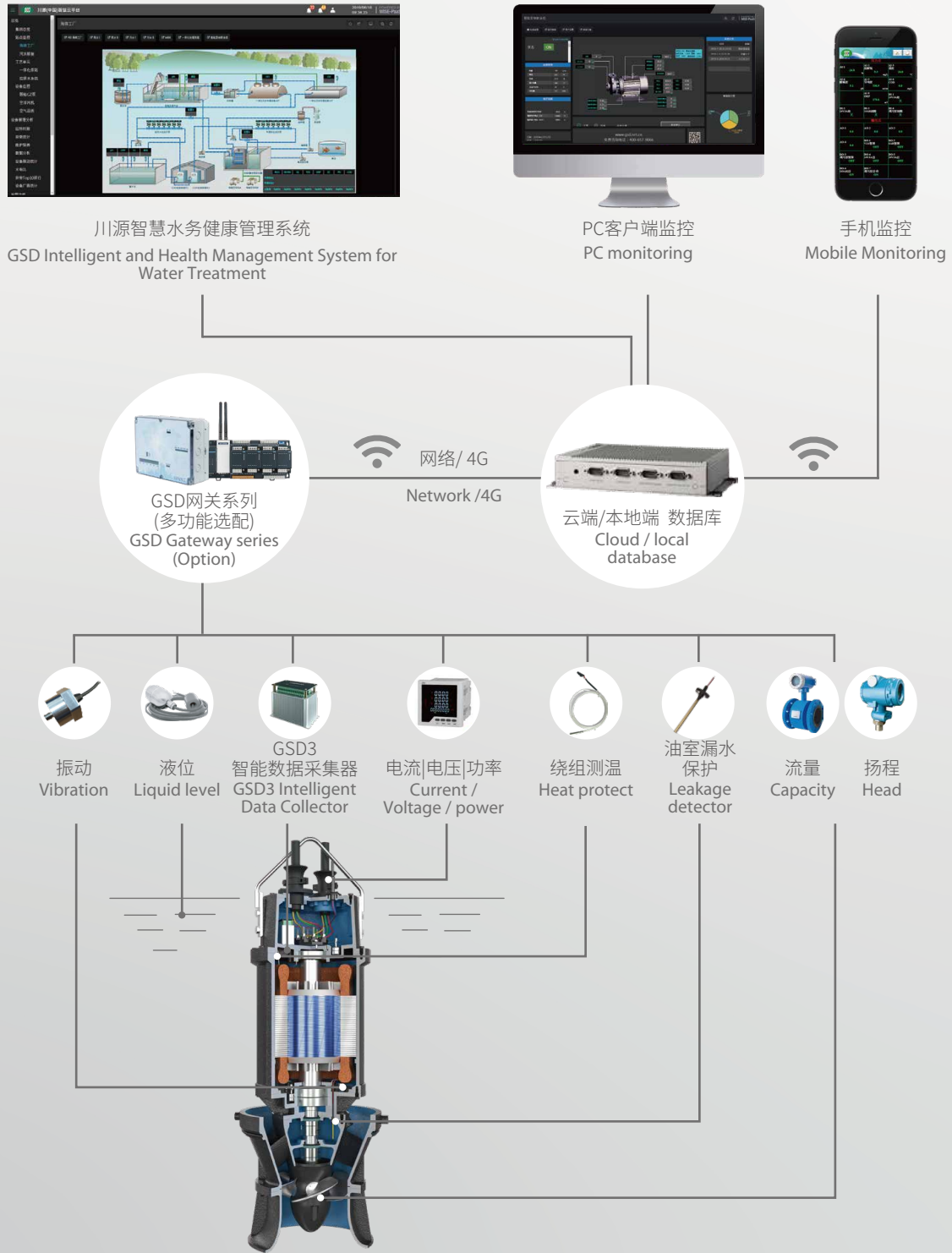



型谱图 Performance chart

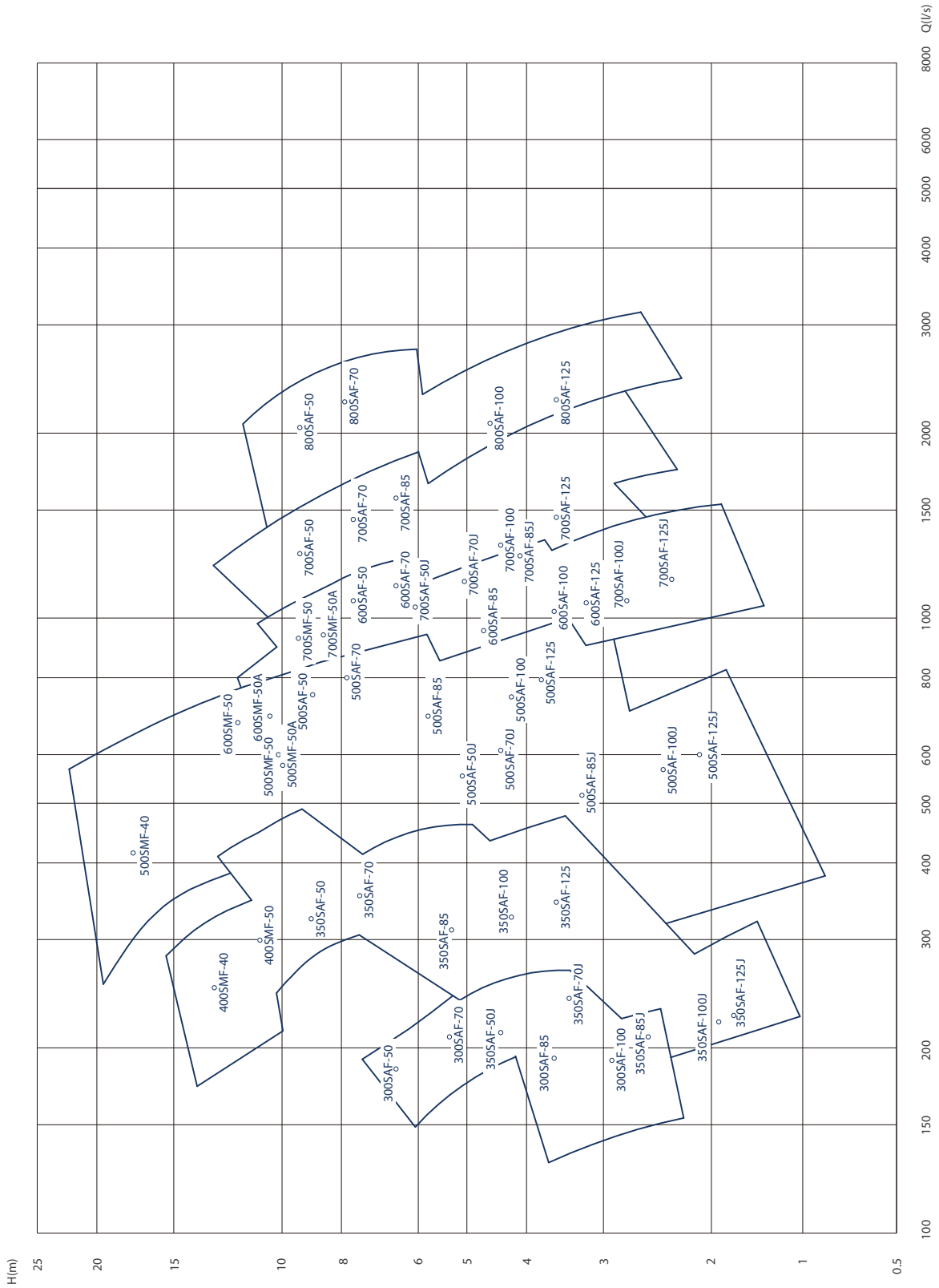

## 性能参数表及性能曲线

### Performance parameter and Performance curve

#### 300SAF-50

叶片安装角度 Installation angle	流量Capacity		扬程Head (m)	转速Speed (r/min)	功率 Power (kW)		效率 Eff. (%)	叶轮直径 D(mm) Impeller diameter
	(m³/h)	(l/s)			轴功率 Shaft power	电机功率 Motor power		
-6°	426	118	7.46	1450	12.3	15	70.60	250
	538	149	5.92		11.1		77.90	
	637	177	3.24		8.6		65.70	
-4°	439	122	7.81		13.2	18.5	70.60	
	584	162	6.11		12.3		79.10	
	692	192	3.18		9.1		65.70	
-2°	461	128	8.03		14.3	18.5	70.60	
	602	167	6.29		13.0		79.10	
	747	207	3.18		9.8		75.70	
0°	534	148	7.92		15.6	18.5	73.70	
	669	186	6.32		14.5		79.30	
	806	224	3.33		11.1		65.70	
+2°	575	160	8.18	17.4	18.5	73.70		
	704	196	6.48	15.7		79.10		
	855	238	3.41	12.1		65.70		
+4°	602	167	8.33	18.5	22	73.70		
	740	206	6.66	17.0		79.10		
	888	247	3.70	13.6		65.70		

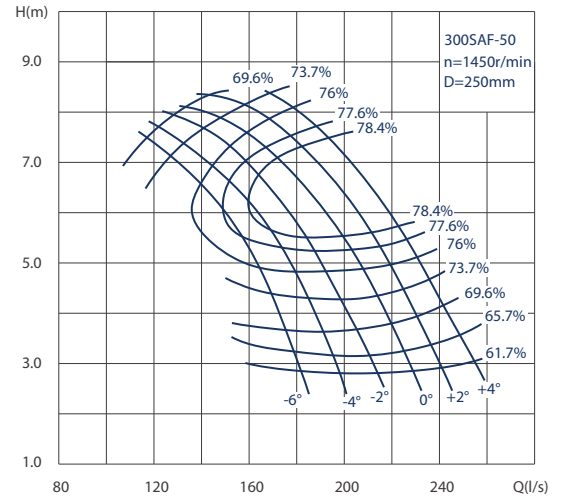

#### 300SAF-70

叶片安装角度 Installation angle	流量Capacity		扬程Head (m)	转速Speed (r/min)	功率 Power (kW)		效率 Eff. (%)	叶轮直径 D(mm) Impeller diameter
	(m³/h)	(l/s)			轴功率 Shaft power	电机功率 Motor power		
-6°	552	153	5.90	1450	11.9	15	74.90	250
	667	185	4.58		10.3		80.90	
	750	208	2.60		6.9		76.90	
-4°	573	159	6.17		12.9	18.5	74.90	
	683	190	4.86		11.0		82.10	
	802	223	2.67		7.6		76.90	
-2°	585	163	6.25		13.3	18.5	74.90	
	719	200	5.07		12.1		82.30	
	844	234	2.78		8.3		76.90	
0°	600	167	6.46		14.1	18.5	74.90	
	748	208	5.29		12.9		83.40	
	885	246	2.99		9.4		76.90	
+2°	606	168	6.53	14.4	18.5	74.90		
	767	213	5.35	13.3		83.80		
	917	255	3.13	10.2		76.90		
+4°	644	179	6.67	15.6	22	74.90		
	796	221	5.69	14.9		82.90		
	963	267	3.40	11.6		76.90		

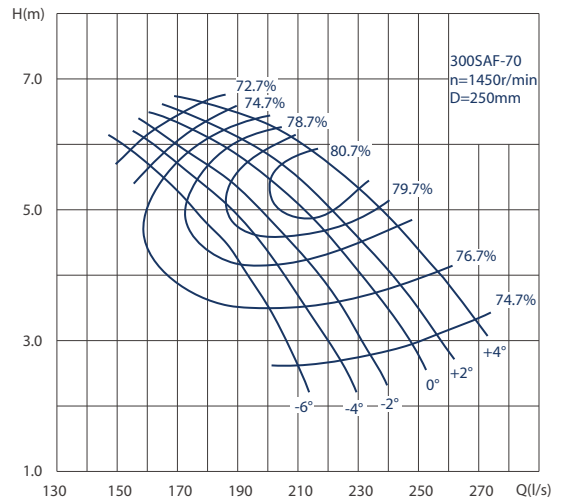

## 性能参数表及性能曲线

### Performance parameter and Performance curve

#### 300SAF-85

叶片安装角度 Installation angle	流量 Capacity		扬程 Head (m)	转速 Speed (r/min)	功率 Power (kW)		效率 Eff. (%)	叶轮直径 D(mm) Impeller diameter
	(m <sup>3</sup> /h)	(l/s)			轴功率 Shaft power	电机功率 Motor power		
-6°	365	101	4.97	1450	7.1	7.5	69.30	250
	517	144	2.94		5.3		78.30	
	565	157	1.94		4.3		69.30	
-4°	400	111	5.27		8.3	11	69.30	
	558	155	3.61		6.9		79.30	
	654	182	1.88		4.8		69.30	
-2°	440	122	5.52		9.5	11	69.30	
	635	177	3.54		7.7		79.30	
	736	204	1.94		5.6		69.30	
0°	484	134	5.73		10.9	11	69.30	
	696	193	3.67		8.7		80.30	
	792	220	2.12		6.6		69.30	
+2°	527	146	5.90	12.2	15	69.30		
	744	207	3.92	10.0		79.30		
	846	235	2.43	8.1		69.30		
+4°	575	160	5.89	13.3	15	69.30		
	760	211	4.44	11.7		78.30		
	900	250	2.73	9.7		69.30		

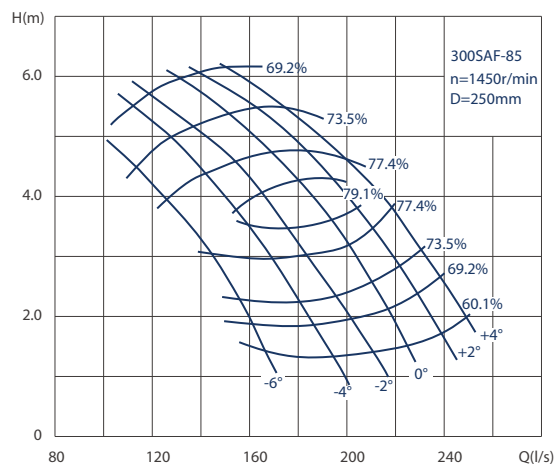

#### 300SAF-100

叶片安装角度 Installation angle	流量 Capacity		扬程 Head (m)	转速 Speed (r/min)	功率 Power (kW)		效率 Eff. (%)	叶轮直径 D(mm) Impeller diameter
	(m <sup>3</sup> /h)	(l/s)			轴功率 Shaft power	电机功率 Motor power		
-6°	469	130	3.68	1450	6.1	7.5	76.70	250
	521	145	2.80		5.1		78.30	
	554	154	2.22		4.4		76.70	
-4°	509	142	3.99		7.2	11	76.70	
	583	162	2.85		5.7		79.80	
	633	176	2.03		4.6		76.70	
-2°	546	152	4.19		8.1	11	76.70	
	635	177	2.92		6.3		80.40	
	690	192	1.98		4.9		76.70	
0°	586	163	4.34		9.0	11	76.70	
	688	191	2.92		6.8		80.70	
	744	207	2.04		5.4		76.70	
+2°	633	176	4.35	9.8	15	76.70		
	729	203	3.08	7.5		81.20		
	792	220	2.20	6.2		76.70		
+4°	698	194	4.17	10.3	15	76.70		
	781	217	3.09	8.1		80.90		
	833	232	2.42	7.2		76.70		

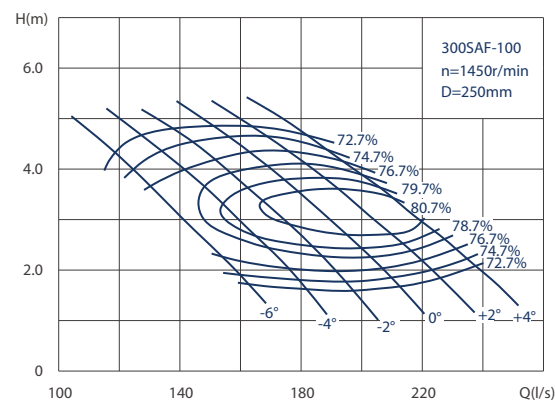

## 性能参数表及性能曲线

### Performance parameter and Performance curve

#### 350SAF-50

叶片安装角度 Installation angle	流量 Capacity		扬程 Head (m)	转速 Speed (r/min)	功率 Power (kW)		效率 Eff. (%)	叶轮直径 D(mm) Impeller diameter
	(m <sup>3</sup> /h)	(l/s)			轴功率 Shaft power	电机功率 Motor power		
-4°	914	254	10.5	1450	33.27	37	78.58	300
	1033	287	8.82		30.79		80.60	
	1137	316	6.82		27.07		78.04	
-2°	972	270	10.6	1450	35.50	45	79.05	300
	1101	306	8.97		33.39		80.60	
	1213	337	6.94		29.36		78.09	
0°	1037	288	10.8	1450	38.30	45	79.64	300
	1177	327	9.08		36.12		80.60	
	1296	360	7.07		31.87		78.30	
+2°	1112	309	10.9	1450	41.30	45	79.96	300
	1253	348	9.20		38.94		80.60	
	1372	381	7.20		34.05		77.96	
+4°	1310	364	9.89	1450	44.06	45	80.10	300
	1346	374	9.35		42.54		80.60	
	1454	404	7.35		37.52		77.60	

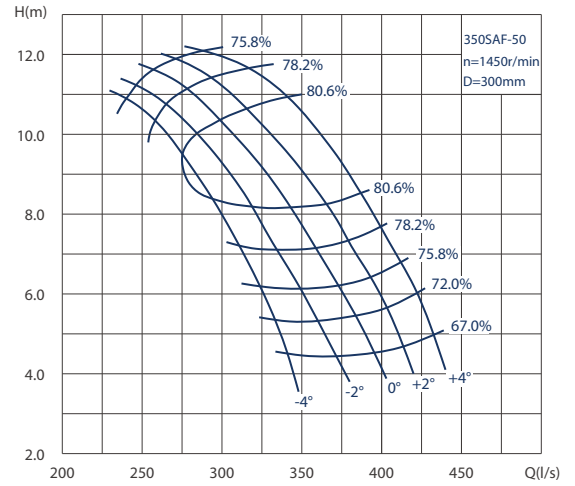

#### 350SAF-50J

叶片安装角度 Installation angle	流量 Capacity		扬程 Head (m)	转速 Speed (r/min)	功率 Power (kW)		效率 Eff. (%)	叶轮直径 D(mm) Impeller diameter
	(m <sup>3</sup> /h)	(l/s)			轴功率 Shaft power	电机功率 Motor power		
-4°	608	169	4.88	980	10.38	15	77.93	300
	673	187	4.34		9.87		80.59	
	706	196	3.97		9.46		80.60	
-2°	648	180	4.92	980	11.04	15	78.67	300
	716	199	4.39		10.63		80.60	
	752	209	4.02		10.22		80.60	
0°	698	194	4.97	980	11.90	15	79.44	300
	767	213	4.44		11.50		80.60	
	803	223	4.08		11.07		80.60	
+2°	749	208	5.02	980	12.81	15	79.94	300
	817	227	4.50		12.43		80.60	
	853	237	4.15		11.96		80.60	
+4°	814	226	5.10	980	14.09	15	80.21	300
	878	244	4.58		13.59		80.60	
	911	253	4.23		13.02		80.60	

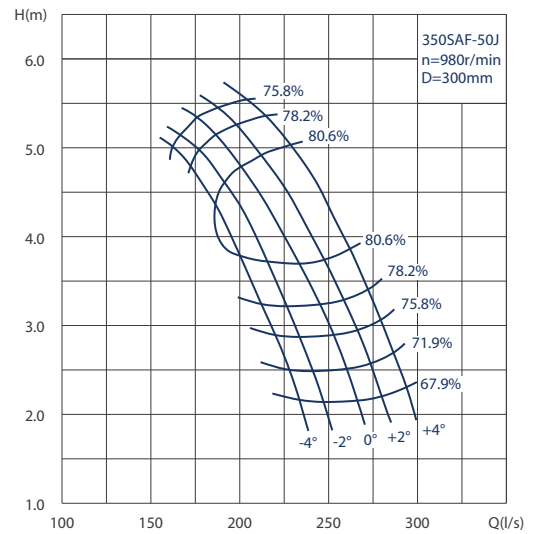

## 性能参数表及性能曲线

### Performance parameter and Performance curve

#### 350SAF-70

叶片安装角度 Installation angle	流量 Capacity		扬程 Head (m)	转速 Speed (r/min)	功率 Power (kW)		效率 Eff. (%)	叶轮直径 D(mm) Impeller diameter	
	(m <sup>3</sup> /h)	(l/s)			轴功率 Shaft power	电机功率 Motor power			
-6°	954	265	8.50	1450	29.1	37	76.00	300	
	1152	320	6.60		25.3		82.00		
	1296	360	3.75		17.0		78.00		
-4°	990	275	8.88		31.5	45	76.00		300
	1181	328	7.00		27.1		83.20		
	1386	385	3.85		18.6		78.00		
-2°	1012	281	9.00		32.6	45	76.00		300
	1242	345	7.30		29.6		83.40		
	1458	405	4.00		20.4		78.00		
0°	1037	288	9.20		34.6	55	76.00		300
	1292	359	7.62		31.8		84.50		
	1530	425	4.30		23.0		78.00		
+2°	1048	291	9.40	35.3	55	76.00	300		
	1325	368	7.70	32.7		84.90			
	1584	440	4.50	24.9		78.00			
+4°	1112	309	9.60	38.3	55	76.00	300		
	1375	382	8.20	36.6		84.00			
	1663	462	4.90	28.5		78.00			

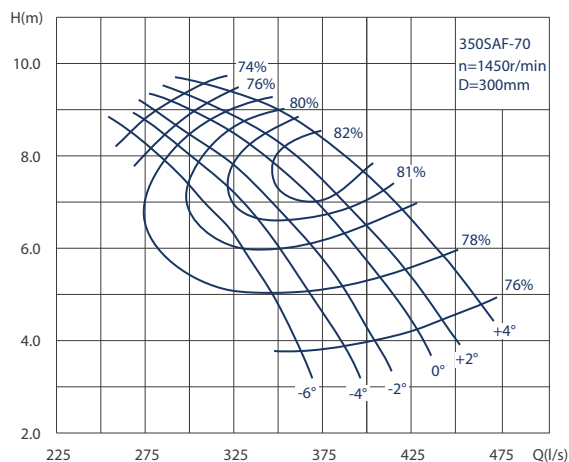

#### 350SAF-70J

叶片安装角度 Installation angle	流量 Capacity		扬程 Head (m)	转速 Speed (r/min)	功率 Power (kW)		效率 Eff. (%)	叶轮直径 D(mm) Impeller diameter	
	(m <sup>3</sup> /h)	(l/s)			轴功率 Shaft power	电机功率 Motor power			
-6°	645	179	3.88	980	9.4	11	72.60	300	
	779	216	3.01		8.1		78.60		
	876	243	1.71		5.5		74.60		
-4°	669	186	4.06		10.2	11	72.60		300
	798	222	3.20		8.7		79.80		
	937	260	1.76		6.0		74.60		
-2°	684	190	4.11		10.5	11	72.60		300
	840	233	3.33		9.5		80.00		
	985	274	1.83		6.6		74.60		
0°	701	195	4.25		11.2	15	72.60		300
	873	243	3.48		10.2		81.10		
	1034	287	1.96		7.4		74.60		
+2°	708	197	4.29	11.4	15	72.60	300		
	895	249	3.52	10.5		81.50			
	1071	297	2.06	8.1		74.60			
+4°	752	209	4.39	12.4	15	72.60	300		
	930	258	3.75	11.8		80.60			
	1124	312	2.24	9.2		74.60			

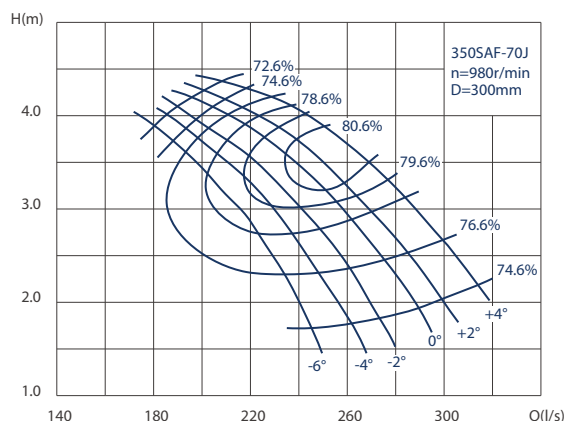

## 性能参数表及性能曲线

### Performance parameter and Performance curve

#### 350SAF-85

叶片安装角度 Installation angle	流量 Capacity		扬程 Head (m)	转速 Speed (r/min)	功率 Power (kW)		效率 Eff. (%)	叶轮直径 D(mm) Impeller diameter
	(m³/h)	(l/s)			轴功率 Shaft power	电机功率 Motor power		
-4°	828	230	6.98	1450	20.8	30	75.79	300
	968	269	5.01		16.4		80.40	
	1094	304	2.64		11.2		70.3	
-2°	900	250	7.15	1450	23.3	30	75.30	300
	1048	291	5.22		18.5		80.40	
	1177	327	2.89		13.0		71.49	
0°	965	268	7.30	1450	25.9	37	74.05	300
	1116	310	5.41		20.5		80.40	
	1246	346	3.10		14.3		73.43	
+2°	1012	281	7.41	1450	27.2	37	75.06	300
	1184	329	5.61		22.5		80.40	
	1332	370	3.39		16.5		74.43	
+4°	1073	298	7.59	1450	29.2	37	75.89	300
	1274	354	5.84		25.2		80.40	
	1411	392	3.67		18.9		74.76	

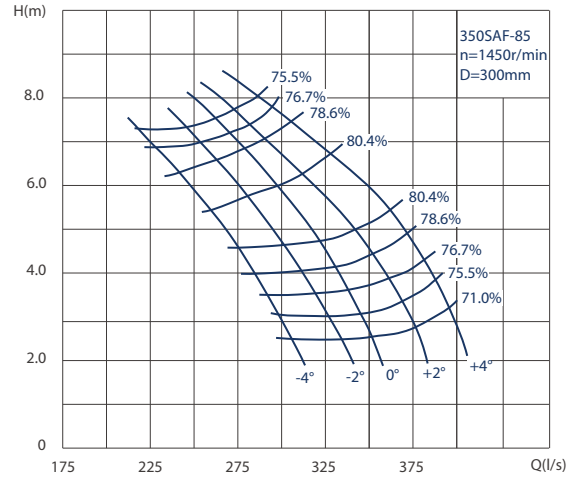

#### 350SAF-85J

叶片安装角度 Installation angle	流量 Capacity		扬程 Head (m)	转速 Speed (r/min)	功率 Power (kW)		效率 Eff. (%)	叶轮直径 D(mm) Impeller diameter
	(m³/h)	(l/s)			轴功率 Shaft power	电机功率 Motor power		
-4°	583	162	3.00	980	6.2	7.5	77.47	300
	644	179	2.41		5.3		80.40	
	713	198	1.55		4.0		75.15	
-2°	634	176	3.09	980	6.9	11	77.32	300
	695	193	2.51		5.9		80.40	
	770	214	1.66		4.5		76.85	
0°	677	188	3.17	980	7.5	11	76.52	300
	742	206	2.60		6.5		80.40	
	817	227	1.77		5.1		77.18	
+2°	709	197	3.23	980	8.1	11	77.34	300
	785	218	2.70		7.2		80.40	
	868	241	1.90		5.8		77.84	
+4°	756	210	3.33	980	8.8	11	78.06	300
	835	232	2.82		8.0		80.40	
	922	256	2.04		6.6		77.96	

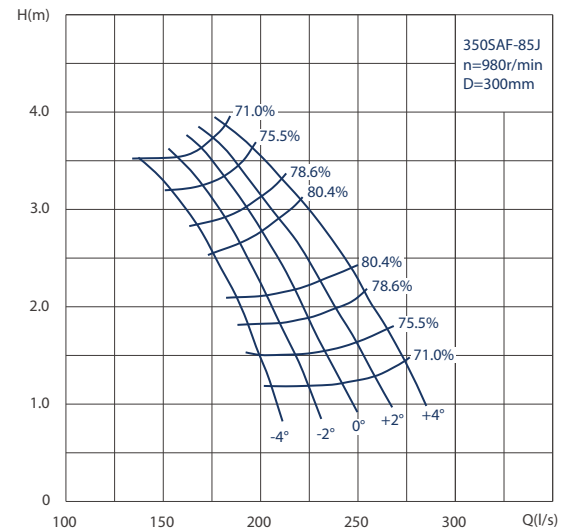

## 性能参数表及性能曲线

### Performance parameter and Performance curve

#### 350SAF-100

叶片安装角度 Installation angle	流量 Capacity		扬程 Head (m)	转速 Speed (r/min)	功率 Power (kW)		效率 Eff. (%)	叶轮直径 D(mm) Impeller diameter
	(m <sup>3</sup> /h)	(l/s)			轴功率 Shaft power	电机功率 Motor power		
-6°	810	225	5.30	1450	15.0	18.5	78.00	300
	900	250	4.03		12.4		79.60	
	958	266	3.20		10.7		78.00	
-4°	880	245	5.75		17.7	22	78.00	
	1008	280	4.10		13.9		81.10	
	1094	304	2.93		11.2		78.00	
-2°	943	262	6.03		19.9	30	78.00	
	1098	305	4.21		15.4		81.70	
	1192	331	2.85		11.9		78.00	
0°	1013	282	6.25		22.1	30	78.00	
	1188	330	4.20		16.6		82.00	
	1285	357	2.94		13.2		78.00	
+2°	1094	304	6.27	24.0	37	78.00		
	1260	350	4.43	18.4		82.50		
	1368	380	3.17	15.2		78.00		
+4°	1206	335	6.00	25.3	37	78.00		
	1350	375	4.45	19.9		82.20		
	1440	400	3.48	17.5		78.00		

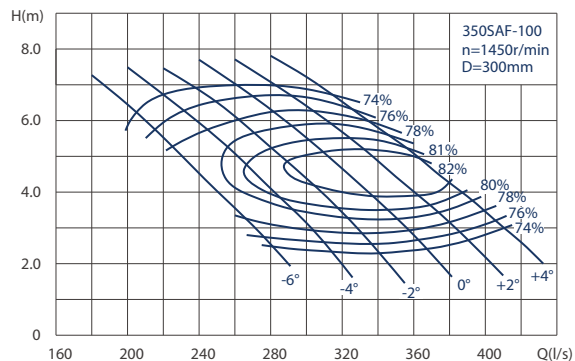

#### 350SAF-100J

叶片安装角度 Installation angle	流量 Capacity		扬程 Head (m)	转速 Speed (r/min)	功率 Power (kW)		效率 Eff. (%)	叶轮直径 D(mm) Impeller diameter
	(m <sup>3</sup> /h)	(l/s)			轴功率 Shaft power	电机功率 Motor power		
-6°	548	152	2.42	980	4.7	7.5	76.60	300
	608	169	1.84		3.9		78.20	
	647	180	1.46		3.4		76.60	
-4°	595	165	2.63		5.6	7.5	76.60	
	681	189	1.87		4.4		79.70	
	740	206	1.34		3.5		76.60	
-2°	638	177	2.75		6.2	11	76.60	
	742	206	1.92		4.8		80.30	
	805	224	1.30		3.7		76.60	
0°	685	190	2.85		6.9	11	76.60	
	803	223	1.92		5.2		80.60	
	869	241	1.34		4.1		76.60	
+2°	740	206	2.86	7.5	11	76.60		
	852	237	2.02	5.8		81.10		
	925	257	1.45	4.8		76.60		
+4°	724	201	3.33	9.86	11	70.26		
	860	239	2.43	7.21		83.39		
	950	264	1.76	5.83		83.08		

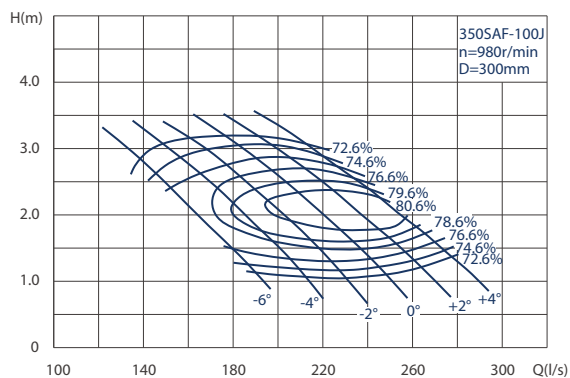

## 性能参数表及性能曲线

### Performance parameter and Performance curve

#### 350SAF-125

叶片安装角度 Installation angle	流量 Capacity		扬程 Head (m)	转速 Speed (r/min)	功率 Power (kW)		效率 Eff. (%)	叶轮直径 D(mm) Impeller diameter
	(m³/h)	(l/s)			轴功率 Shaft power	电机功率 Motor power		
-4°	745	207	4.56	1450	12.1	15	76.66	300
	914	254	2.84		8.8		80.40	
	1004	279	1.72		6.4		73.61	
-2°	925	257	4.86	1450	15.7	22	77.76	300
	1091	303	3.19		11.8		80.40	
	1188	330	2.12		8.8		77.79	
0°	1080	300	5.17	1450	19.9	30	76.50	300
	1260	350	3.60		15.4		80.40	
	1368	380	2.59		12.3		78.71	
+2°	1202	334	5.46	1450	23.9	30	74.95	300
	1400	389	3.97		18.8		80.40	
	1516	421	3.01		15.7		79.02	
+4°	1364	379	5.88	1450	31.0	37	70.42	300
	1573	437	4.49		24.4		78.83	
	1692	470	3.58		21.1		78.05	

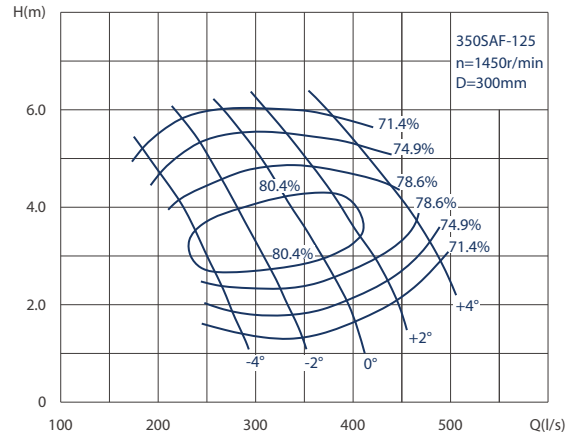

#### 350SAF-125J

叶片安装角度 Installation angle	流量 Capacity		扬程 Head (m)	转速 Speed (r/min)	功率 Power (kW)		效率 Eff. (%)	叶轮直径 D(mm) Impeller diameter
	(m³/h)	(l/s)			轴功率 Shaft power	电机功率 Motor power		
-4°	504	140	2.07	980	3.7	7.5	76.62	300
	612	170	1.35		2.8		80.40	
	695	193	0.66		1.7		71.66	
-2°	619	172	2.26	980	4.9	7.5	77.37	300
	724	201	1.56		3.8		80.40	
	817	227	0.84		2.5		75.42	
0°	713	198	2.45	980	6.3	11	75.70	300
	828	230	1.80		5.0		80.40	
	947	263	1.06		3.6		76.94	
+2°	788	219	2.61	980	7.6	11	73.97	300
	911	253	2.01		6.2		80.10	
	1048	291	1.25		4.6		77.43	
+4°	875	243	2.84	980	10.0	11	67.57	300
	1026	285	1.93		6.8		79.60	
	1166	324	1.50		6.3		76.14	

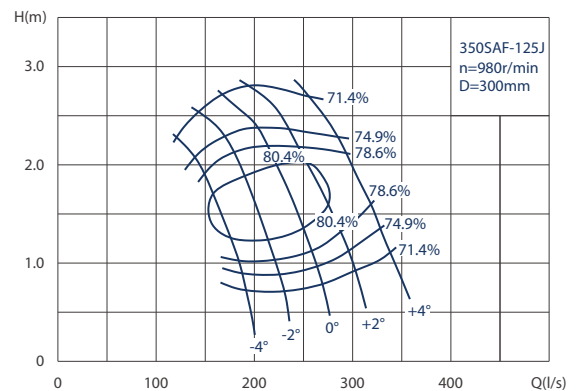



## 性能参数表及性能曲线

### Performance parameter and Performance curve

#### 500SAF-50

叶片安装角度 Installation angle	流量 Capacity		扬程 Head (m)	转速 Speed (r/min)	功率 Power (kW)		效率 Eff. (%)	叶轮直径 D(mm) Impeller diameter
	(m <sup>3</sup> /h)	(l/s)			轴功率 Shaft power	电机功率 Motor power		
-4°	1969	547	11.3	980	78.2	90	77.50	450
	2401	667			70.4		81.70	
	2689	747			58.6		74.89	
-2°	2099	583	11.4	980	83.5	110	78.02	450
	2556	710			75.8		81.70	
	2869	797			63.8		75.09	
0°	2250	625	11.6	980	90.0	110	78.94	450
	2728	758			82.0		81.70	
	3064	851			69.4		75.54	
+2°	2419	672	11.7	980	97.1	110	79.37	450
	2902	806			88.5		81.70	
	3240	900			76.1		74.65	
+4°	2635	732	12.0	980	107.5	110	80.12	450
	3107	863			96.5		81.70	
	3420	950			82.6		74.42	

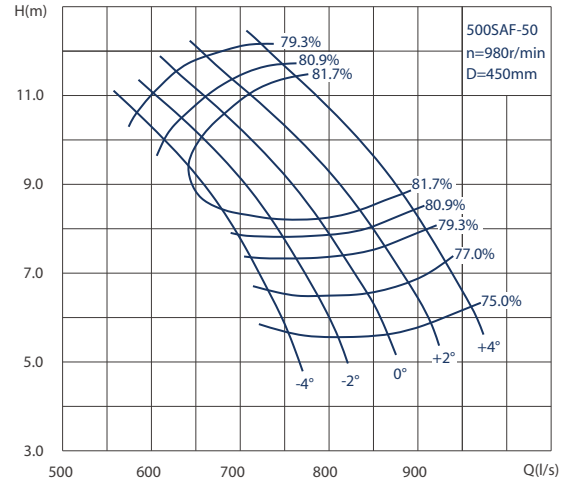

#### 500SAF-50J

叶片安装角度 Installation angle	流量 Capacity		扬程 Head (m)	转速 Speed (r/min)	功率 Power (kW)		效率 Eff. (%)	叶轮直径 D(mm) Impeller diameter
	(m <sup>3</sup> /h)	(l/s)			轴功率 Shaft power	电机功率 Motor power		
-4°	1559	433	5.98	740	31.8	37	79.80	450
	1778	494			29.2		81.70	
	1948	541			25.2		78.82	
-2°	1656	460	6.04	740	33.9	45	80.24	450
	1890	525			31.6		81.70	
	2077	577			27.6		78.84	
0°	1771	492	6.12	740	36.5	45	80.85	450
	2012	559			34.2		81.70	
	2210	614			30.2		79.09	
+2°	1897	527	6.21	740	39.5	45	81.19	450
	2135	593			37.0		81.70	
	2336	649			32.9		78.94	
+4°	2059	572	6.34	740	43.7	45	81.45	450
	2286	635			40.6		81.70	
	2473	687			36.0		78.68	

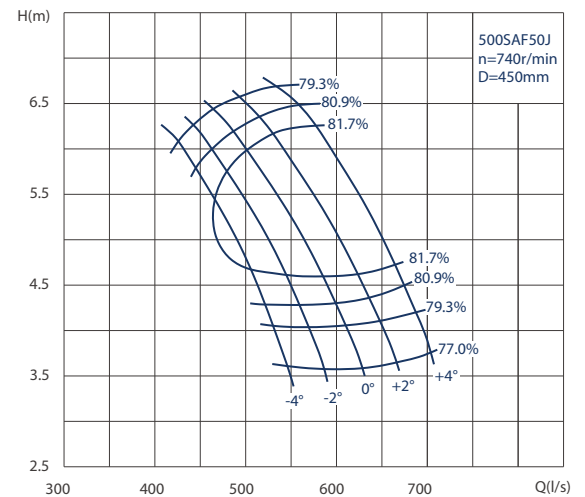

## 性能参数表及性能曲线

### Performance parameter and Performance curve

#### 500SAF-70

叶片安装角度 Installation angle	流量 Capacity		扬程 Head (m)	转速 Speed (r/min)	功率 Power (kW)		效率 Eff. (%)	叶轮直径 D(mm) Impeller diameter
	(m³/h)	(l/s)			轴功率 Shaft power	电机功率 Motor power		
-6°	2176	605	8.74	980	67.1	75	77.20	450
	2628	730	6.78		58.3		83.20	
	2956	821	3.85		39.2		79.20	
-4°	2258	627	9.13		72.8	90	77.20	
	2694	748	7.19		62.5		84.40	
	3162	878	3.96		43.1		79.20	
-2°	2308	641	9.25		75.3	110	77.20	
	2833	787	7.50		68.4		84.60	
	3326	924	4.11		47.0		79.20	
0°	2365	657	9.56		79.8	132	77.20	
	2948	819	7.83		73.4		85.70	
	3490	969	4.42		53.1		79.20	
+2°	2390	664	9.66	81.5		77.20		
	3022	839	7.91	75.7		86.10		
	3613	1004	4.62	57.4		79.20		
+4°	2537	705	9.87	88.4		77.20		
	3137	871	8.43	84.6		85.20		
	3794	1054	5.04	65.8		79.20		

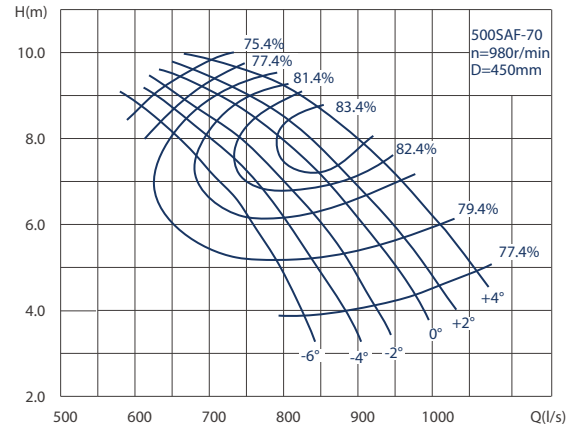

#### 500SAF-70J

叶片安装角度 Installation angle	流量 Capacity		扬程 Head (m)	转速 Speed (r/min)	功率 Power (kW)		效率 Eff. (%)	叶轮直径 D(mm) Impeller diameter
	(m³/h)	(l/s)			轴功率 Shaft power	电机功率 Motor power		
-6°	1632	453	4.91	740	28.6	37	76.40	450
	1971	547	3.82		24.9		82.40	
	2217	616	2.17		16.7		78.40	
-4°	1694	471	5.13		31.0	45	76.40	
	2020	561	4.05		26.7		83.60	
	2371	659	2.23		18.4		78.40	
-2°	1731	481	5.20		32.1	45	76.40	
	2125	590	4.22		29.2		83.80	
	2494	693	2.31		20.0		78.40	
0°	1774	493	5.38		34.0		76.40	
	2211	614	4.41		31.3		84.90	
	2618	727	2.49		22.7		78.40	
+2°	1792	498	5.43	34.7		76.40		
	2267	630	4.45	32.2		85.30		
	2710	753	2.60	24.5		78.40		
+4°	1903	529	5.55	37.7	45	76.40		
	2353	654	4.74	36.0		84.40		
	2845	790	2.83	28.0		78.40		

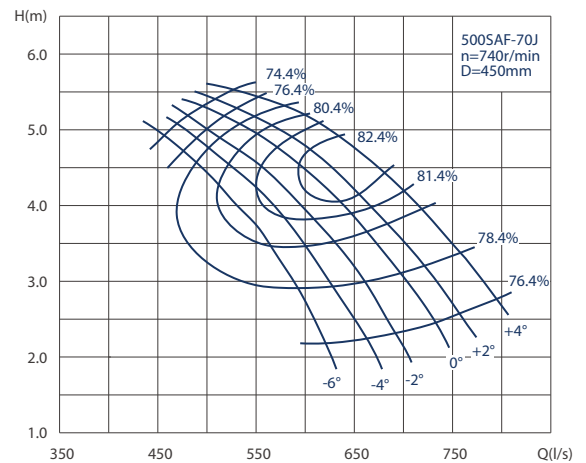

## 性能参数表及性能曲线

### Performance parameter and Performance curve

#### 500SAF-85

叶片 安装 角度 Installation angle	流量 Capacity		扬程 Head (m)	转速 Speed (r/min)	功率 Power (kW)		效率 Eff. (%)	叶轮 直径 D(mm) Impeller diameter
	(m <sup>3</sup> /h)	(l/s)			轴功率 Shaft power	电机功率 Motor power		
-4°	1937	538	6.93	980	51.1	55	71.55	450
	2178	605	5.38		39.2		81.50	
	2466	685	3.01		27.8		72.59	
-2°	2102	584	7.10	980	52.4	75	77.52	450
	2358	655	5.59		46.3		81.50	
	2657	738	3.26		31.6		74.66	
0°	2257	627	7.27	980	58.0	75	77.01	450
	2520	700	5.78		48.7		81.50	
	2812	781	3.47		34.5		77.12	
+2°	2362	656	7.39	980	61.3	75	77.52	450
	2664	740	5.97		53.1		81.50	
	3006	835	3.75		39.7		77.25	
+4°	2520	700	7.58	980	66.2	75	78.57	450
	2837	788	6.21		58.9		81.50	
	3186	885	4.03		45.2		77.34	

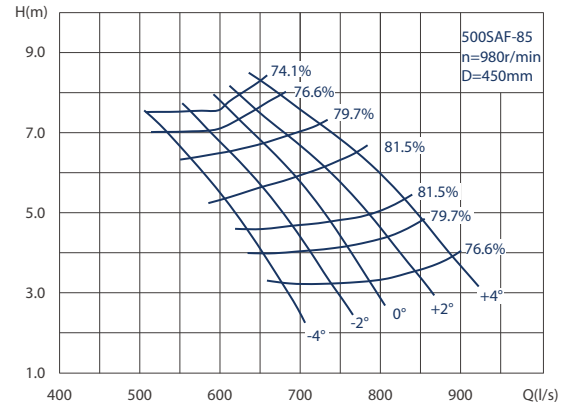

#### 500SAF-85J

叶片 安装 角度 Installation angle	流量 Capacity		扬程 Head (m)	转速 Speed (r/min)	功率 Power (kW)		效率 Eff. (%)	叶轮 直径 D(mm) Impeller diameter
	(m <sup>3</sup> /h)	(l/s)			轴功率 Shaft power	电机功率 Motor power		
-4°	1346	374	4.21	740	20.7	30	74.72	450
	1613	448	3.03		16.3		81.50	
	1775	493	2.08		12.9		78.06	
-2°	1465	407	4.30	740	23.2	30	73.81	450
	1746	485	3.15		18.4		81.50	
	1912	531	2.22		14.7		78.82	
0°	1559	433	4.38	740	25.6	30	72.71	450
	1681	517	3.27		20.3		81.50	
	2030	564	2.35		16.4		79.38	
+2°	1627	452	4.44	740	27.1	37	72.56	450
	1969	547	3.38		22.2		81.50	
	2160	600	2.51		18.5		79.78	
+4°	1721	478	4.53	740	29.2	37	72.82	450
	2092	581	3.52		24.6		81.50	
	2290	636	2.67		20.8		80.04	

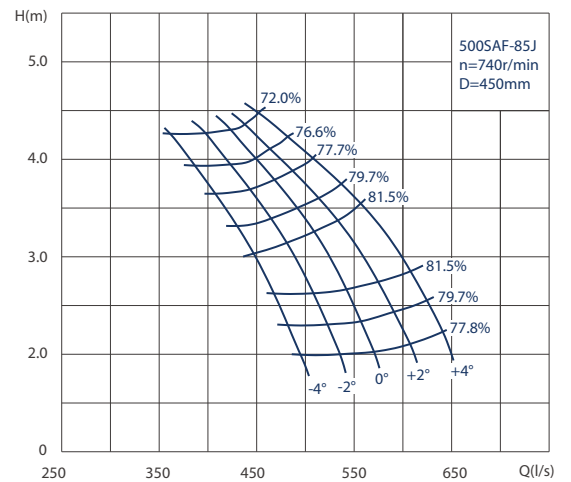

## 性能参数表及性能曲线

### Performance parameter and Performance curve

#### 500SAF-100

叶片安装角度 Installation angle	流量 Capacity		扬程 Head (m)	转速 Speed (r/min)	功率 Power (kW)		效率 Eff. (%)	叶轮直径 D(mm) Impeller diameter
	(m <sup>3</sup> /h)	(l/s)			轴功率 Shaft power	电机功率 Motor power		
-6°	1848	513	5.45	980	34.6	45	79.40	450
	2053	570	4.14		28.6		81.00	
	2185	607	3.29		24.7		79.40	
-4°	2008	558	5.91		40.7	55	79.40	
	2299	639	4.21		32.0		82.50	
	2496	693	3.01		25.8		79.40	
-2°	2151	598	6.20		45.8	75	79.40	
	2504	696	4.33		35.6		83.10	
	2718	755	2.93		27.3		79.40	
0°	2312	642	6.42		50.9		79.40	
	2710	753	4.32		38.2		83.40	
	2932	814	3.02		30.4		79.40	
+2°	2496	693	6.44	55.2		79.40		
	2874	798	4.55	42.5		83.90		
	3121	867	3.26	34.9		79.40		
+4°	2751	764	6.17	58.2		79.40		
	3079	855	4.57	45.9		83.60		
	3285	912	3.58	40.4		79.40		

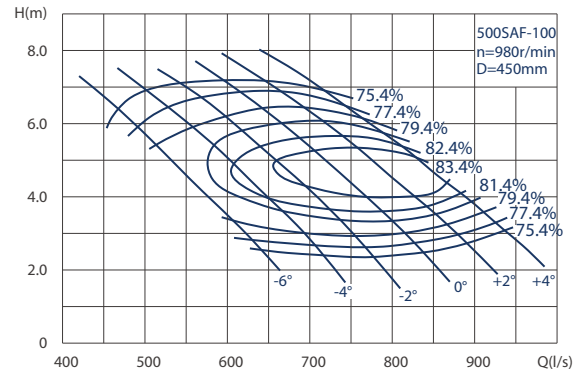

#### 500SAF-100J

叶片安装角度 Installation angle	流量 Capacity		扬程 Head (m)	转速 Speed (r/min)	功率 Power (kW)		效率 Eff. (%)	叶轮直径 D(mm) Impeller diameter
	(m <sup>3</sup> /h)	(l/s)			轴功率 Shaft power	电机功率 Motor power		
-6°	1386	385	3.06	740	14.7	22	78.50	450
	1540	428	2.33		12.2		80.10	
	1638	455	1.85		10.5		78.50	
-4°	1506	418	3.32		17.4	30	78.50	
	1724	479	2.37		13.6		81.60	
	1872	520	1.69		11.0		78.50	
-2°	1614	448	3.49		19.5		78.50	
	1879	522	2.43		15.1		82.20	
	2039	566	1.65		11.7		78.50	
0°	1734	482	3.61		21.7		78.50	
	2033	565	2.43		16.3		82.50	
	2199	611	1.70		13.0		78.50	
+2°	1872	520	3.62	23.5		78.50		
	2156	599	2.56	18.1		83.00		
	2340	650	1.83	14.9		78.50		
+4°	2063	573	3.47	24.9		78.50		
	2309	642	2.57	19.6		82.70		
	2464	684	2.01	17.2		78.50		

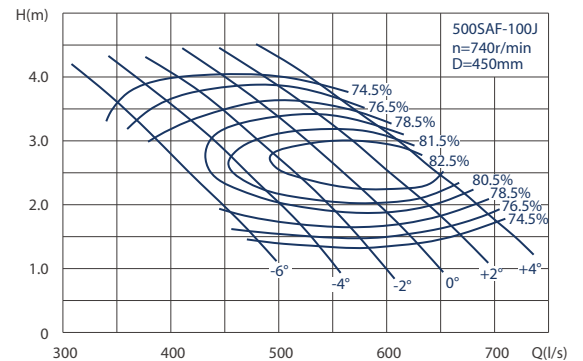

## 性能参数表及性能曲线

### Performance parameter and Performance curve

#### 500SAF-125

叶片安装角度 Installation angle	流量 Capacity		扬程 Head (m)	转速 Speed (r/min)	功率 Power (kW)		效率 Eff. (%)	叶轮直径 D(mm) Impeller diameter	
	(m <sup>3</sup> /h)	(l/s)			轴功率 Shaft power	电机功率 Motor power			
-6°	1447	402	3.74	980	18.9	37	77.84	450	
	1681	467	2.56		15.1		77.79		
	1879	522	1.01		6.9		74.59		
-4°	1850	514	4.05		25.3	45	80.52		
	2088	580	2.91		20.3		81.50		
	2376	660	1.41		12.2		75.05		
-2°	2239	622	4.42		33.4	55	80.65		
	2473	687	3.32		27.4		81.50		
	2754	765	1.89		17.7		79.86		
0°	2599	722	4.82		42.6	75	80.00		
	2855	793	3.80		36.2		81.50		
	3121	867	2.42		25.3		81.44		
+2°	2873	798	5.17	51.4		78.63			
	3150	875	4.21	44.3		81.50			
	3477	966	2.88	33.3		82.00			
+4°	3236	899	5.69	67.8		73.92			
	3528	980	4.80	58.3		79.16			
	3848	1069	3.50	45.1		81.25			

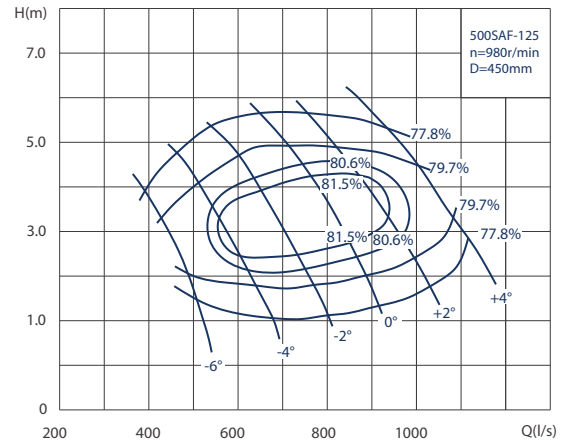

#### 500SAF-125J

叶片安装角度 Installation angle	流量 Capacity		扬程 Head (m)	转速 Speed (r/min)	功率 Power (kW)		效率 Eff. (%)	叶轮直径 D(mm) Impeller diameter	
	(m <sup>3</sup> /h)	(l/s)			轴功率 Shaft power	电机功率 Motor power			
-6°	1012	281	2.30	740	8.4	11	75.81	450	
	1231	342	1.50		6.4		79.00		
	1379	383	0.88		4.6		71.90		
-4°	1318	366	2.44		11.0	15	79.33		
	1541	428	1.67		7.9		81.50		
	1688	469	1.07		6.5		75.60		
-2°	1620	450	2.62		14.5	22	79.93		
	1840	511	1.87		11.5		81.50		
	1994	554	1.29		8.8		79.55		
0°	1886	524	2.80		18.2	30	79.04		
	2128	591	2.10		14.9		81.50		
	2304	640	1.55		12.1		80.37		
+2°	2099	583	2.97	21.9	37	77.64			
	2362	656	2.30	18.1		81.50			
	2552	709	1.79	15.4		80.63			
+4°	2383	662	3.22	28.5		73.27			
	2660	739	2.60	23.6		79.70			
	2851	792	2.11	20.5		79.73			

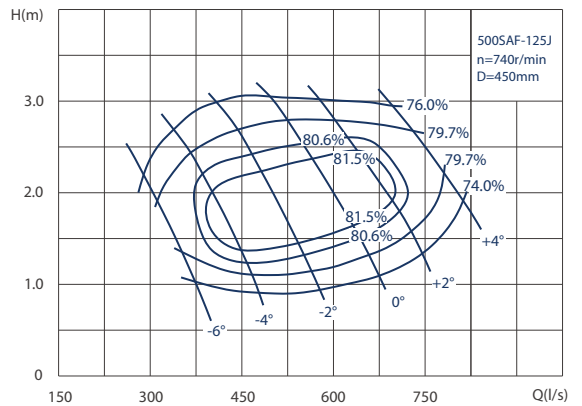

## 性能参数表及性能曲线

### Performance parameter and Performance curve

#### 600SAF-50

叶片安装角度 Installation angle	流量 Capacity		扬程 Head (m)	转速 Speed (r/min)	功率 Power (kW)		效率 Eff. (%)	叶轮直径 D(mm) Impeller diameter
	(m³/h)	(l/s)			轴功率 Shaft power	电机功率 Motor power		
-4°	2812	781	9.02	740	86.5	110	79.81	550
	3222	895	7.47		79.7		82.20	
	3668	1019	4.86		64.9		74.84	
-2°	2981	828	9.15	740	92.5	110	80.29	550
	3434	954	7.56		86.0		82.20	
	3917	1088	4.98		70.9		74.97	
0°	3179	883	9.30	740	99.6	132	80.82	550
	3884	1079	7.66		98.6		82.20	
	4180	1161	5.12		77.3		75.42	
+2°	3391	942	9.48	740	108.0	132	81.05	550
	3902	1084	7.78		100.6		82.20	
	4421	1228	5.25		84.6		74.71	
+4°	3665	1018	9.73	740	119.5	132	81.23	550
	4180	1161	7.92		109.7		82.20	
	4666	1296	5.40		92.2		74.41	

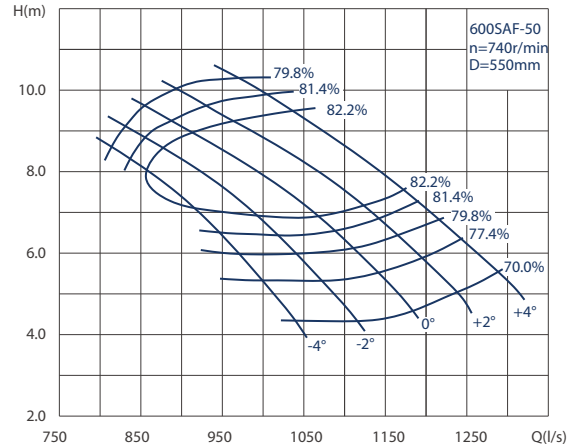

#### 600SAF-70

叶片安装角度 Installation angle	流量 Capacity		扬程 Head (m)	转速 Speed (r/min)	功率 Power (kW)		效率 Eff. (%)	叶轮直径 D(mm) Impeller diameter
	(m³/h)	(l/s)			轴功率 Shaft power	电机功率 Motor power		
-4°	3920	914	7.42	740	84.8	110	78.45	550
	3715	1032	6.23		76.6		82.32	
	4064	1129	4.72		66.7		78.36	
-2°	3492	970	7.59	740	90.6	110	79.67	550
	3924	1090	6.40		83.2		82.24	
	4298	1194	4.92		72.0		80.02	
0°	3686	1024	7.71	740	96.2	132	80.45	550
	4144	1151	6.58		88.4		84.03	
	4903	1362	5.14		84.3		81.44	
+2°	3895	1082	7.88	740	102.4	132	81.60	550
	4352	1209	6.77		94.7		84.70	
	4774	1326	5.37		85.1		82.03	
+4°	4126	1146	8.07	740	110.4	132	82.14	550
	4597	1277	6.99		103.3		84.70	
	5018	1394	5.62		93.3		82.30	
+6°	4334	1204	8.25	740	118.2	132	82.36	550
	4817	1338	7.21		111.7		84.70	
	5263	1462	5.88		102.3		82.42	

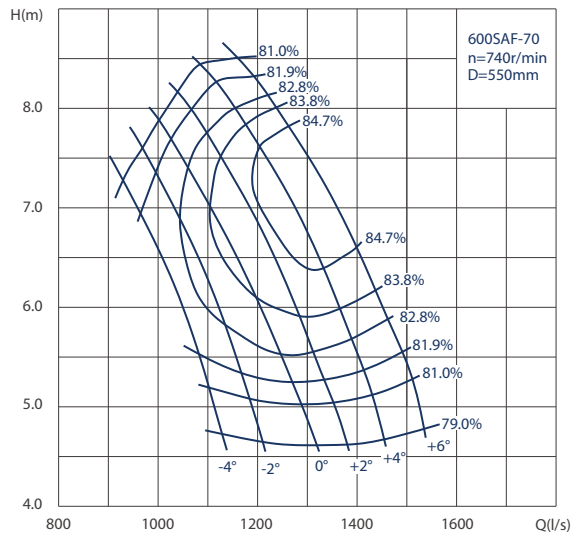

## 性能参数表及性能曲线

### Performance parameter and Performance curve

#### 600SAF-85

叶片安装角度 Installation angle	流量 Capacity		扬程 Head (m)	转速 Speed (r/min)	功率 Power (kW)		效率 Eff. (%)	叶轮直径 D(mm) Impeller diameter
	(m <sup>3</sup> /h)	(l/s)			轴功率 Shaft power	电机功率 Motor power		
-4°	2560	711	5.98	740	53.9	75	77.3	550
	2984	829	4.35		43.1		82.0	
	3391	942	2.26		29.2		71.6	
-2°	2783	773	6.12	740	60.5	75	76.6	550
	3229	897	4.53		48.6		82.0	
	3650	1014	2.48		33.6		73.3	
0°	2984	829	6.25	740	67.3	90	75.5	550
	3449	958	4.71		53.9		82.0	
	3866	1074	2.67		37.4		75.2	
+2°	3114	865	6.35	740	70.9	90	76.0	550
	3643	1012	4.87		58.9		82.0	
	4129	1147	2.92		43.1		76.2	
+4°	3316	921	6.50	740	76.1	90	77.1	550
	3877	1077	5.08		65.4		82.0	
	4374	1215	3.16		49.1		76.6	

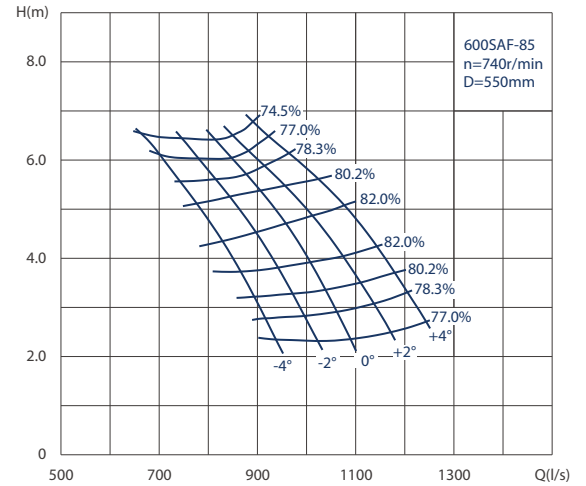

#### 600SAF-100

叶片安装角度 Installation angle	流量 Capacity		扬程 Head (m)	转速 Speed (r/min)	功率 Power (kW)		效率 Eff. (%)	叶轮直径 D(mm) Impeller diameter
	(m <sup>3</sup> /h)	(l/s)			轴功率 Shaft power	电机功率 Motor power		
-6°	2530	703	4.58	740	39.6	45	79.80	550
	2811	781	3.48		32.8		81.40	
	2991	831	2.76		28.2		79.80	
-4°	2749	764	4.97	740	46.7	55	79.80	550
	3149	875	3.54		36.6		82.90	
	3418	950	2.53		29.5		79.80	
-2°	2946	818	5.21	740	52.4	75	79.80	550
	3430	953	3.64		40.7		83.50	
	3722	1034	2.46		31.3		79.80	
0°	3166	879	5.40	740	58.4	75	79.80	550
	3711	1031	3.63		43.8		83.80	
	4014	1115	2.54		34.8		79.80	
+2°	3418	950	5.41	740	63.1	75	79.80	550
	3936	1093	3.83		48.7		84.30	
	4273	1187	2.74		40.0		79.80	
+4°	3767	1046	5.18	740	66.6	75	79.80	550
	4217	1171	3.84		52.5		84.00	
	4498	1249	3.01		46.2		79.80	

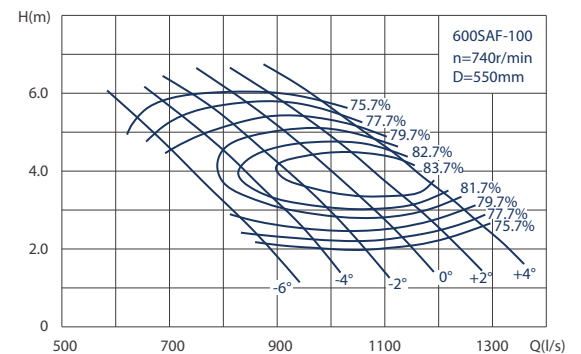

## 性能参数表及性能曲线

### Performance parameter and Performance curve

#### 600SAF-125

叶片安装角度 Installation angle	流量 Capacity		扬程 Head (m)	转速 Speed (r/min)	功率 Power (kW)		效率 Eff. (%)	叶轮直径 D(mm) Impeller diameter
	(m³/h)	(l/s)			轴功率 Shaft power	电机功率 Motor power		
-6°	1800	500	3.57	740	24.9	30	75.47	550
	2293	637	2.10		18.0		78.24	
	2628	730	0.89		9.0		75.95	
-4°	2329	647	3.82		33.0	37	78.65	
	2833	787	2.42		24.4		82.00	
	3172	881	1.24		15.8		73.41	
-2°	2866	796	4.14		43.7	55	79.32	
	3355	932	2.79		33.3		82.00	
	3719	1033	1.68		23.3		78.17	
0°	3326	924	4.47		55.6	75	77.84	
	3859	1072	3.21		44.0		82.00	
	4259	1183	2.18		33.7		80.20	
+2°	3676	1021	4.75	67.0		76.04		
	4244	1179	3.56	53.8		82.00		
	4680	1300	2.61	44.0		80.92		
+4°	4136	1149	5.16	88.1	110	70.65		
	4748	1319	4.08	71.5		79.08		
	5184	1440	3.18	59.7		80.44		

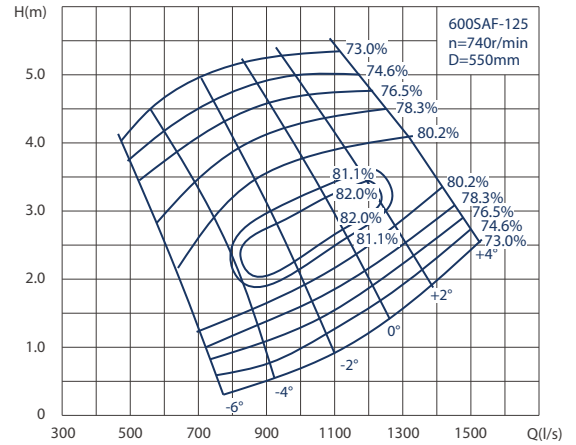

#### 700SAF-50

叶片安装角度 Installation angle	流量 Capacity		扬程 Head (m)	转速 Speed (r/min)	功率 Power (kW)		效率 Eff. (%)	叶轮直径 D(mm) Impeller diameter
	(m³/h)	(l/s)			轴功率 Shaft power	电机功率 Motor power		
-6°	2982	828	11.04	740	120.3	132	74.60	600
	3766	1046	8.77		109.9		81.90	
	4463	1240	4.80		83.8		69.70	
-4°	3077	855	11.56		129.9		74.60	
	4095	1138	9.04		121.4		83.10	
	4847	1346	4.71		89.3		69.70	
-2°	3229	897	11.88		140.1	160	74.60	
	4219	1172	9.31		128.8		83.10	
	5233	1454	4.71		96.4		69.70	
0°	3436	954	11.32		138.0		77.70	
	4685	1302	9.35		143.3		83.30	
	5190	1442	4.81		93.64		69.70	
+2°	4027	1119	12.11	171.0	200	77.70		
	4932	1370	9.59	155.1		83.10		
	5992	1665	5.04	118.1		69.70		
+4°	4216	1171	12.33	182.3		77.70		
	5187	1441	9.85	167.5		83.10		
	6220	1728	5.47	133.0		69.70		

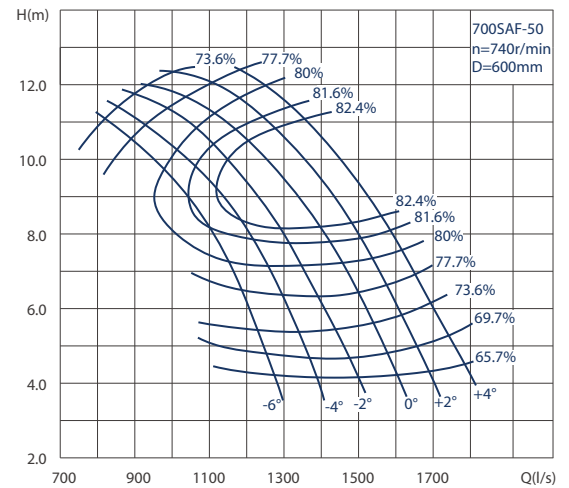



## 性能参数表及性能曲线

### Performance parameter and Performance curve

#### 700SAF-50J

叶片安装角度 Installation angle	流量 Capacity		扬程 Head (m)	转速 Speed (r/min)	功率 Power (kW)		效率 Eff. (%)	叶轮直径 D(mm) Impeller diameter
	(m <sup>3</sup> /h)	(l/s)			轴功率 Shaft power	电机功率 Motor power		
-6°	2394	665	7.12	590	62.9	75	73.80	600
	3023	840	5.65		57.4		81.10	
	3583	995	3.09		43.8		68.90	
-4°	2470	686	7.45		67.9	90	73.80	
	3287	913	5.82		63.3		82.30	
	3891	1081	3.03		46.6		68.90	
-2°	2592	720	7.66		73.3	110	73.80	
	3386	941	6.00		67.3		82.30	
	4200	1167	3.03		50.3		68.90	
0°	3004	834	7.55		80.4		76.90	
	3761	1045	6.02		74.8		82.50	
	4536	1260	3.18		57.0		68.90	
+2°	3232	898	7.80	89.3		76.90		
	3959	1100	6.18	81.0		82.30		
	4810	1336	3.25	61.8		68.90		
+4°	3385	940	7.95	95.4		76.90		
	4164	1157	6.35	87.5		82.30		
	4993	1387	3.53	69.7		68.90		

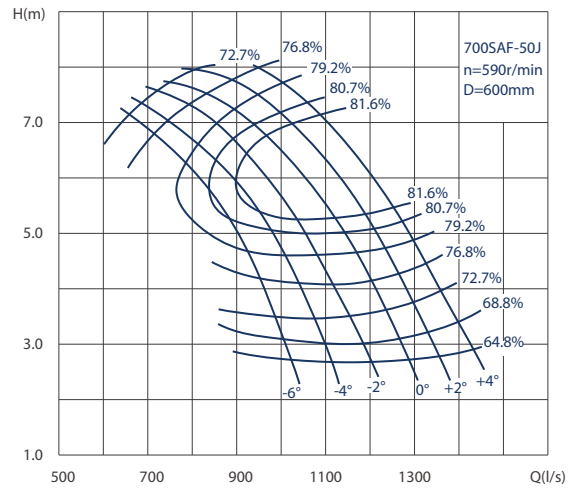

#### 700SAF-70

叶片安装角度 Installation angle	流量 Capacity		扬程 Head (m)	转速 Speed (r/min)	功率 Power (kW)		效率 Eff. (%)	叶轮直径 D(mm) Impeller diameter
	(m <sup>3</sup> /h)	(l/s)			轴功率 Shaft power	电机功率 Motor power		
-6°	3869	1075	8.74	740	120.8	132	76.30	600
	4672	1298	6.78		104.9		82.30	
	5256	1460	3.85		70.4		78.30	
-4°	4015	1115	9.13		130.9	160	76.30	
	4788	1330	7.19		112.4		83.50	
	5620	1561	3.96		77.5		78.30	
-2°	4102	1140	9.25		135.5		76.30	
	5036	1399	7.50		123.0		83.70	
	5912	1642	4.11		84.6		78.30	
0°	4204	1168	9.56		143.6		76.30	
	5241	1456	7.83		131.9		84.80	
	6204	1723	4.42		95.4		78.30	
+2°	4248	1180	9.66	146.6		76.30		
	5372	1492	7.91	135.9		85.20		
	6424	1784	4.62	103.3		78.30		
+4°	4511	1253	9.87	159.0	185	76.30		
	5577	1549	8.43	152.0		84.30		
	6745	1874	5.04	118.3		78.30		

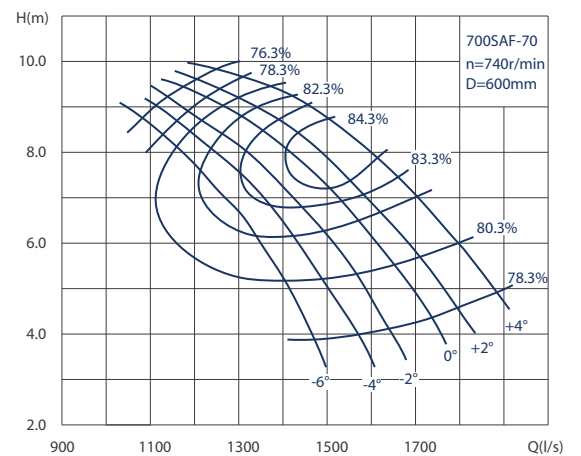

## 性能参数表及性能曲线

### Performance parameter and Performance curve

#### 700SAF-70J

叶片安装角度 Installation angle	流量 Capacity		扬程 Head (m)	转速 Speed (r/min)	功率 Power (kW)		效率 Eff. (%)	叶轮直径 D(mm) Impeller diameter	
	(m³/h)	(l/s)			轴功率 Shaft power	电机功率 Motor power			
-6°	3105	863	5.63	590	63.0	75	75.60	600	
	3750	1042	4.37		54.7		81.60		
	4219	1172	2.48		36.7		77.60		
-4°	3223	895	5.88		68.3	75	75.60		600
	3844	1068	4.64		58.7		82.80		
	4512	1253	2.55		40.4		77.60		
-2°	3293	915	5.96		70.7	90	75.60		600
	4043	1123	4.83		64.1		83.00		
	4746	1318	2.65		44.2		77.60		
0°	3375	938	6.16		74.9	90	75.60		600
	4207	1169	5.05		68.8		84.10		
	4980	1383	2.85		49.8		77.60		
+2°	3410	947	6.23	76.6	90	75.60	600		
	4312	1198	5.10	70.9		84.50			
	5156	1432	2.98	54.0		77.60			
+4°	3621	1006	6.36	83.0	90	75.60	600		
	4477	1244	5.43	79.2		83.60			
	5414	1504	3.25	61.8		77.60			

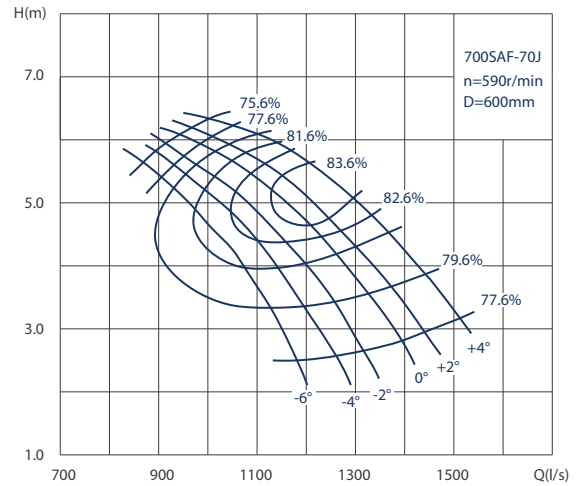

#### 700SAF-85

叶片安装角度 Installation angle	流量 Capacity		扬程 Head (m)	转速 Speed (r/min)	功率 Power (kW)		效率 Eff. (%)	叶轮直径 D(mm) Impeller diameter	
	(m³/h)	(l/s)			轴功率 Shaft power	电机功率 Motor power			
-4°	4514	1254	7.51	740	114.72	132	80.48	650	
	4914	1365	6.12		99.39		82.40		
	5551	1542	3.36		69.59		72.99		
-2°	4900	1361	7.71		127.73	160	80.54		650
	5324	1479	6.34		111.57		82.40		
	5987	1663	3.65		79.59		74.77		
0°	5260	1461	7.91		140.02	160	80.91		650
	5688	1580	6.56		123.32		82.40		
	6343	1762	3.89		87.11		74.14		
+2°	5522	1534	8.02		148.89	185	81.01		650
	6019	1672	6.78		134.88		82.40		
	6786	1885	4.21		100.27		77.59		
+4°	5904	1640	8.30	163.54	185	81.60	650		
	6419	1783	7.05	149.56		82.40			
	7189	1997	4.52	113.91		77.69			

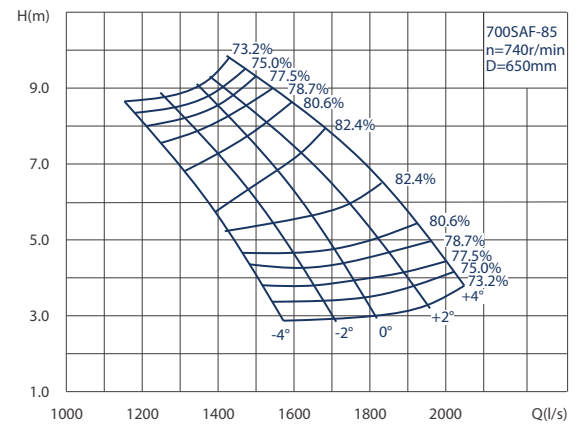

## 性能参数表及性能曲线

### Performance parameter and Performance curve

#### 700SAF-85J

叶片安装角度 Installation angle	流量 Capacity		扬程 Head (m)	转速 Speed (r/min)	功率 Power (kW)		效率 Eff. (%)	叶轮直径 D(mm) Impeller diameter
	(m³/h)	(l/s)			轴功率 Shaft power	电机功率 Motor power		
-4°	3539	983	5.17	590	63.20	90	78.84	650
	4018	1116	3.86		51.25		82.40	
	4507	1252	2.15		36.26		72.78	
-2°	3852	1070	5.29	590	70.22	110	79.03	650
	4349	1208	4.01		57.63		82.40	
	4871	1353	2.26		40.75		73.57	
0°	4126	1146	5.41	590	77.53	110	78.40	650
	4640	1289	4.15		63.65		82.40	
	5177	1438	2.36		44.52		74.74	
+2°	4338	1205	5.51	590	82.11	110	79.28	650
	4925	1368	4.30		69.99		82.40	
	5562	1545	2.49		50.11		75.27	
+4°	4558	1266	5.56	590	87.55	110	80.21	650
	5245	1457	4.47		77.49		82.40	
	5922	1645	2.62		56.76		74.44	

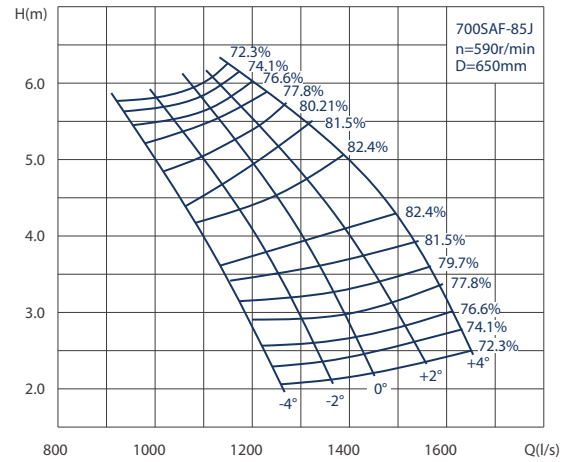

#### 700SAF-100

叶片安装角度 Installation angle	流量 Capacity		扬程 Head (m)	转速 Speed (r/min)	功率 Power (kW)		效率 Eff. (%)	叶轮直径 D(mm) Impeller diameter
	(m³/h)	(l/s)			轴功率 Shaft power	电机功率 Motor power		
-6°	3285	912	5.45	740	60.7	75	80.30	600
	3650	1014	4.14		50.3		81.90	
	3883	1079	3.29		43.4		80.30	
-4°	3569	992	5.91	740	71.6	90	80.30	600
	4087	1135	4.21		56.2		83.40	
	4438	1233	3.01		45.3		80.30	
-2°	3825	1063	6.20	740	80.5	90	80.30	600
	4453	1237	4.33		62.5		84.00	
	4832	1342	2.93		48.0		80.30	
0°	4109	1142	6.42	740	89.5	110	80.30	600
	4818	1338	4.32		67.3		84.30	
	5212	1448	3.02		53.4		80.30	
+2°	4438	1233	6.44	740	97.0	110	80.30	600
	5110	1419	4.55		74.7		84.80	
	5548	1541	3.26		61.4		80.30	
+4°	4891	1359	6.17	740	102.4	110	80.30	600
	5475	1521	4.57		80.7		84.50	
	5840	1622	3.58		70.9		80.30	

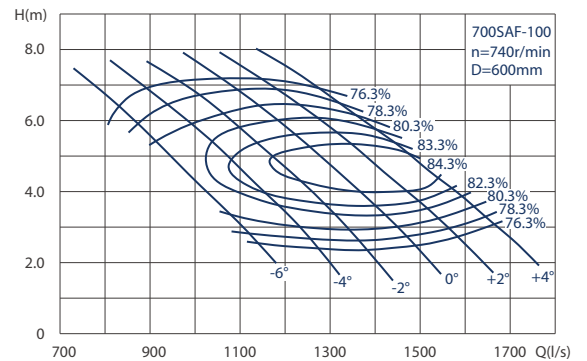

## 性能参数表及性能曲线

### Performance parameter and Performance curve

#### 700SAF-100J

叶片安装角度 Installation angle	流量 Capacity		扬程 Head (m)	转速 Speed (r/min)	功率 Power (kW)		效率 Eff. (%)	叶轮直径 D(mm) Impeller diameter
	(m <sup>3</sup> /h)	(l/s)			轴功率 Shaft power	电机功率 Motor power		
-6°	2637	732	3.51	590	31.7	37	79.60	600
	2930	814	2.67		26.3		81.20	
	3117	866	2.12		22.6		79.60	
-4°	2865	796	3.81		37.4	45	79.60	
	3281	911	2.72		29.4		82.70	
	3563	990	1.94		23.7		79.60	
-2°	3070	853	3.99		41.9	55	79.60	
	3574	993	2.79		32.6		83.30	
	3879	1078	1.89		25.1		79.60	
0°	3299	916	4.14		46.8	79.60	79.60	
	3867	1074	2.78		35.0		83.60	
	4184	1162	1.95		27.9		79.60	
+2°	3563	990	4.15	50.6	79.60	79.60		
	4102	1139	2.93	38.9		84.10		
	4453	1237	2.10	32.0		79.60		
+4°	3926	1091	3.97	53.4	79.60	79.60		
	4395	1221	2.95	42.2		83.80		
	4688	1302	2.30	36.9		79.60		

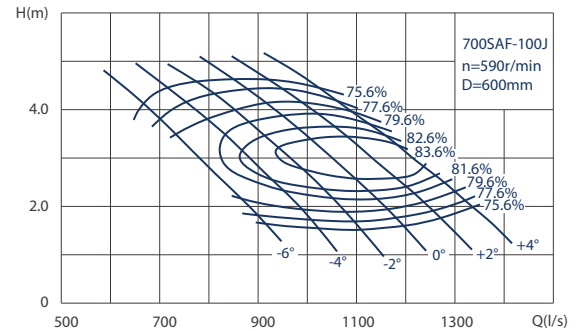

#### 700SAF-125

叶片安装角度 Installation angle	流量 Capacity		扬程 Head (m)	转速 Speed (r/min)	功率 Power (kW)		效率 Eff. (%)	叶轮直径 D(mm) Impeller diameter
	(m <sup>3</sup> /h)	(l/s)			轴功率 Shaft power	电机功率 Motor power		
-4°	2890	803	5.07	740	53.5	55	74.70	600
	3621	1006	3.11		37.8		81.20	
	3971	1103	2.10		29.6		76.70	
-2°	3533	981	5.49		70.8	75	74.70	
	4482	1245	3.23		48.3		81.60	
	4861	1350	2.09		36.1		76.70	
0°	4248	1180	5.76		89.3	110	74.70	
	5285	1468	3.56		62.4		82.20	
	5737	1594	2.34		47.7		76.70	
+2°	4920	1367	5.76		103.4	74.70	74.70	
	5869	1630	3.68		72.1		81.60	
	6380	1772	2.77		62.8		76.70	
+4°	5956	1655	5.56	120.8	74.70	74.70		
	6672	1853	4.07	91.9		80.50		
	6964	1934	3.56	88.1		76.70		

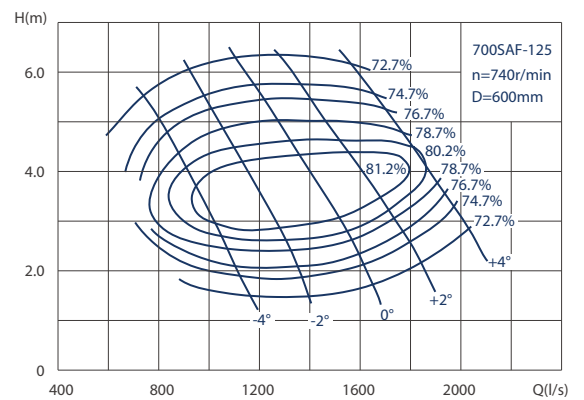

## 性能参数表及性能曲线

### Performance parameter and Performance curve

#### 700SAF-125J

叶片安装角度 Installation angle	流量 Capacity		扬程 Head (m)	转速 Speed (r/min)	功率 Power (kW)		效率 Eff. (%)	叶轮直径 D(mm) Impeller diameter
	(m <sup>3</sup> /h)	(l/s)			轴功率 Shaft power	电机功率 Motor power		
-4°	2320	645	3.26	590	27.9	30	73.90	600
	2906	807	2.01		19.8		80.40	
	3187	885	1.35		15.4		75.90	
-2°	2836	788	3.54	590	37.0	45	73.90	600
	3598	999	2.08		25.2		80.80	
	3902	1084	1.34		18.8		75.90	
0°	3410	947	3.71	590	46.7	55	73.90	600
	4242	1178	2.29		32.5		81.40	
	4606	1279	1.51		25.0		75.90	
+2°	3949	1097	3.71	590	54.0	75	73.90	600
	4711	1309	2.37		37.7		80.80	
	5121	1423	1.79		32.9		75.90	
+4°	4781	1328	3.58	590	63.1	75	73.90	600
	5355	1488	2.62		48.0		79.70	
	5590	1553	2.29		46.0		75.90	

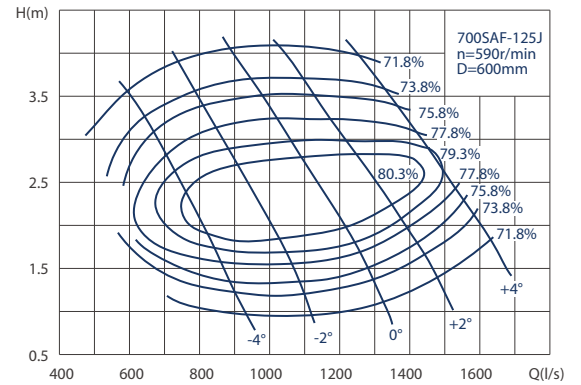

#### 800SAF-50

叶片安装角度 Installation angle	流量 Capacity		扬程 Head (m)	转速 Speed (r/min)	功率 Power (kW)		效率 Eff. (%)	叶轮直径 D(mm) Impeller diameter
	(m <sup>3</sup> /h)	(l/s)			轴功率 Shaft power	电机功率 Motor power		
-6°	4675	1299	11.12	590	188.1	200	75.3	750
	5905	1640	8.83		171.9		82.6	
	6998	1944	4.83		130.8		70.4	
-4°	4824	1340	11.64	590	203.1	225	75.3	750
	6420	1783	9.1		189.8		83.8	
	7599	2111	4.74		139.3		70.4	
-2°	5062	1406	11.96	590	218.9	250	75.3	750
	6614	1837	9.37		201.4		83.8	
	8204	2279	4.74		150.4		70.4	
0°	5866	1629	11.8	590	240.4	250	75.3	750
	7364	2040	9.14		224		83.8	
	8859	2461	4.97		170.3		70.4	
+2°	6313	1754	12.19	590	267.4	280	78.4	750
	7733	2148	9.65		242.5		83.8	
	9395	2610	5.08		184.6		70.4	
+4°	6610	1836	12.42	590	285.2	315	78.4	750
	8132	2259	9.92		262.2		83.8	
	9752	2709	5.51		207.9		70.4	

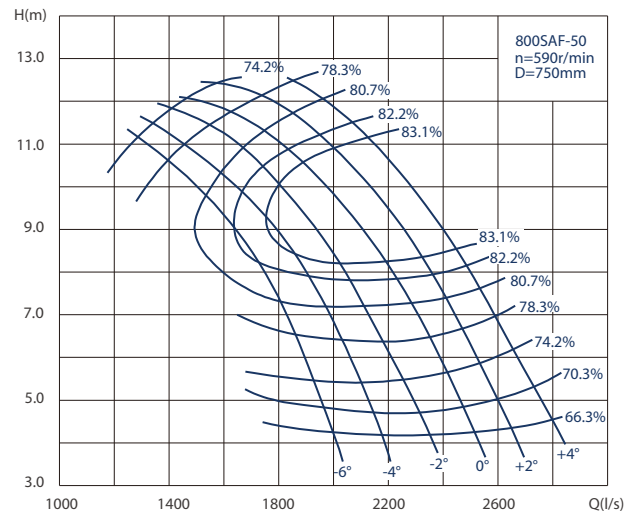

## 性能参数表及性能曲线

### Performance parameter and Performance curve

#### 800SAF-70

叶片安装角度 Installation angle	流量 Capacity		扬程 Head (m)	转速 Speed (r/min)	功率 Power (kW)		效率 Eff. (%)	叶轮直径 D(mm) Impeller diameter
	(m <sup>3</sup> /h)	(l/s)			轴功率 Shaft power	电机功率 Motor power		
-6°	6065	1685	8.8	590	189	200	73.7	750
	7324	2034	6.83		164.3		81.4	
	8240	2289	3.88		110.4		74.5	
-4°	6294	1748	9.19		204.8	225	77.0	
	7507	2085	7.24		176		82.8	
	8812	2248	3.98		121.1		74.4	
-2°	6431	1786	9.31		212	250	78.1	
	7896	2193	7.55		192.6		82.8	
	9270	2448	4.14		132.5		74.7	
0°	6592	1786	9.62		224.6	250	79.7	
	8217	2193	7.89		206.8		82.8	
	9727	2575	4.45		149.4		75.1	
+2°	6660	1831	9.73	229.5	280	666		
	8423	2283	7.97	213.1		864		
	10071	2702	4.66	162		986		
+4°	7072	1964	9.93	248.6	280	810		
	8743	2429	8.49	238.1		986		
	10574	2937	5.07	185		1102		

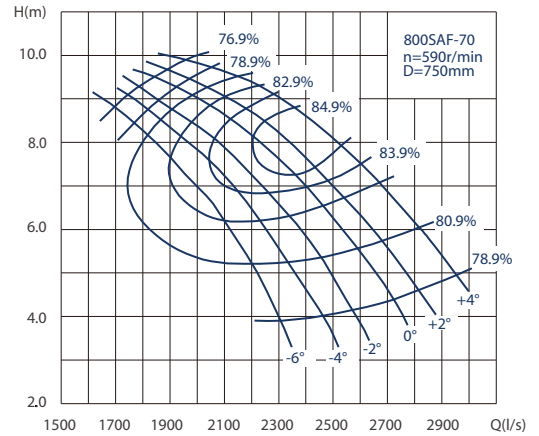

#### 800SAF-100

叶片安装角度 Installation angle	流量 Capacity		扬程 Head (m)	转速 Speed (r/min)	功率 Power (kW)		效率 Eff. (%)	叶轮直径 D(mm) Impeller diameter
	(m <sup>3</sup> /h)	(l/s)			轴功率 Shaft power	电机功率 Motor power		
-6°	5150	1413	5.48	590	94.9	110	81	750
	5722	1589	4.17		78.6		82.6	
	6088	1691	3.31		67.7		81	
-4°	5596	1554	5.95		111.9	132	81	
	6409	1780	4.24		88		84.1	
	6958	1933	3.03		70.9		81	
-2°	5997	1666	6.24		125.8	160	81	
	6981	1939	4.36		97.9		84.7	
	7576	2104	2.95		75.1		81	
0°	6443	1790	6.47		140.2	160	81	
	7553	2098	4.35		105.3		85	
	8171	2270	3.04		83.5		81	
+2°	6958	1933	6.49	151.8	185	81		
	8011	2225	4.58	116.9		85.5		
	8697	2416	3.28	95.9		81		
+4°	7667	2130	6.21	160.1	185	81		
	8583	2384	4.6	126.2		85.2		
	9155	2543	3.6	110.8		81		

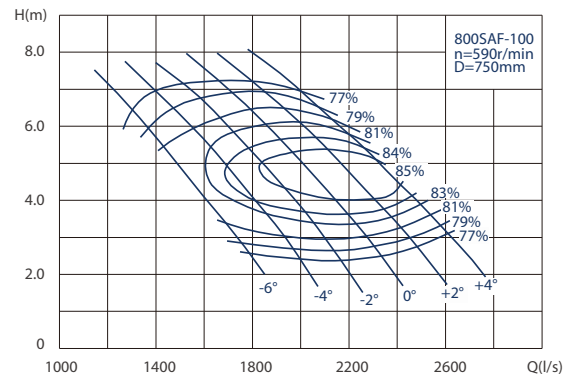

## 性能参数表及性能曲线

### Performance parameter and Performance curve

#### 800SAF-125

叶片安装角度 Installation angle	流量 Capacity		扬程 Head (m)	转速 Speed (r/min)	功率 Power (kW)		效率 Eff. (%)	叶轮直径 D(mm) Impeller diameter
	(m <sup>3</sup> /h)	(l/s)			轴功率 Shaft power	电机功率 Motor power		
-4°	4532	1259	5.1	590	83.4	90	75.5	750
	5676	1577	3.14		59.2		85	
	6226	1729	2.11		46.2		77.5	
-2°	5539	1539	5.53	590	110.5	132	75.5	750
	7027	1952	3.25		75.5		82.4	
	7622	2117	2.1		56.2		77.5	
0°	6660	1850	5.79	590	139.1	160	75.5	750
	8285	2301	3.58		97.3		83	
	8995	2499	2.36		74.6		77.5	
+2°	7713	2143	5.79	590	161.1	185	75.5	750
	9201	2556	3.7		112.5		82.4	
	10002	2778	2.79		98		77.5	
+4°	9338	2594	5.6	590	188.6	200	75.5	750
	10460	2906	4.1		143.7		81.3	
	10918	3033	3.58		137.4		77.5	

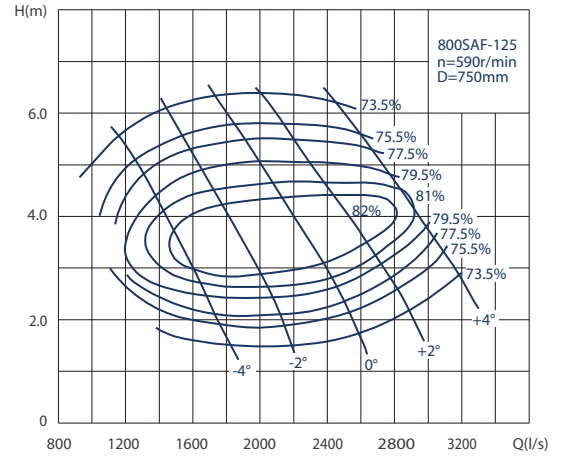

#### 400SMF-40

叶片安装角度 Installation angle	流量 Capacity		扬程 Head (m)	转速 Speed (r/min)	功率 Power (kW)		效率 Eff. (%)	叶轮直径 D(mm) Impeller diameter
	(m <sup>3</sup> /h)	(l/s)			轴功率 Shaft power	电机功率 Motor power		
-4°	630	175	13.8	1450	29.25	37	80.95	284
	756	210	11.7		28.38		84.89	
	868	241	8.61		24.72		82.28	
-2°	752	209	14.0	1450	34.59	45	82.93	284
	864	240	11.8		32.55		85.30	
	983	273	8.79		28.70		81.95	
0°	799	222	14.9	1450	39.25	45	82.62	284
	925	257	13.0		38.40		85.30	
	1094	304	8.98		32.90		81.36	
+2°	925	257	15.2	1450	45.53	75	84.11	284
	1030	286	13.5		44.38		85.30	
	1217	338	9.21		37.79		80.76	
+4°	1026	285	15.5	1450	51.39	75	84.27	284
	1130	314	13.8		49.80		85.30	
	1328	369	9.44		41.57		82.16	

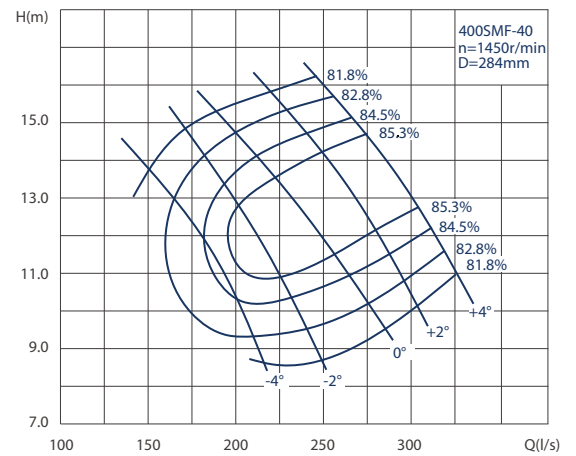

## 性能参数表及性能曲线

### Performance parameter and Performance curve

#### 400SMF-50

叶片安装角度 Installation angle	流量 Capacity		扬程 Head (m)	转速 Speed (r/min)	功率 Power (kW)		效率 Eff. (%)	叶轮直径 D(mm) Impeller diameter
	(m <sup>3</sup> /h)	(l/s)			轴功率 Shaft power	电机功率 Motor power		
-4°	666	185	14.43	1450	35.51	45	73.7	311
	864	240	10.60		30.64		81.4	
	986	274	6.62		23.87		74.5	
-2°	810	225	14.63		41.91	75	77.0	
	986	274	10.82		35.10		82.8	
	1102	306	6.85		27.62		74.4	
0°	889	247	14.76		45.76	75	78.1	
	1076	299	11.00		38.94		82.8	
	1206	335	7.08		31.13		74.7	
+2°	1008	280	14.98		51.60	75	79.7	
	1206	335	11.28		44.74		82.8	
	1305	375	7.43		36.37		75.1	

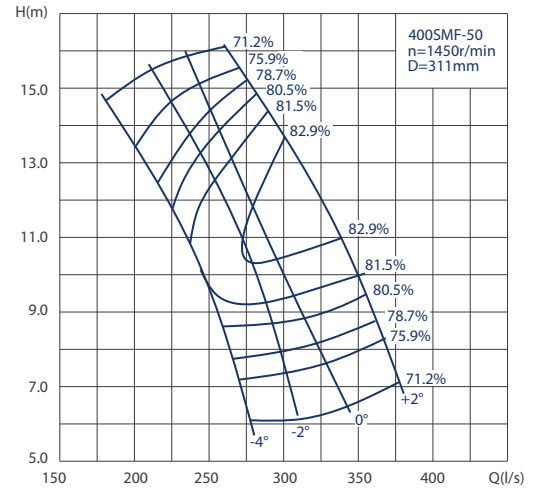

#### 500SMF-40

叶片安装角度 Installation angle	流量 Capacity		扬程 Head (m)	转速 Speed (r/min)	功率 Power (kW)		效率 Eff. (%)	叶轮直径 D(mm) Impeller diameter
	(m <sup>3</sup> /h)	(l/s)			轴功率 Shaft power	电机功率 Motor power		
-4°	932	259	19.58	1450	61.67	75	80.62	333
	1271	353	15.07		61.14		85.30	
	1310	364	14.14		59.47		84.85	
-2°	1159	322	19.89		76.52	90	82.06	
	1343	373	17.21		73.56		85.55	
	1483	412	14.46		68.83		84.86	
0°	1314	365	20.15		86.33	110	83.52	
	1512	420	17.52		84.28		85.60	
	1656	460	14.82		79.22		84.37	
+2°	1523	423	20.54		100.24	132	84.98	
	1602	445	19.50		99.38		85.60	
	1843	512	15.25		91.91		83.29	
+4°	1688	469	20.89	112.67	132	85.25		
	1764	490	19.86	111.46		85.60		
	2009	558	15.68	104.33		82.22		

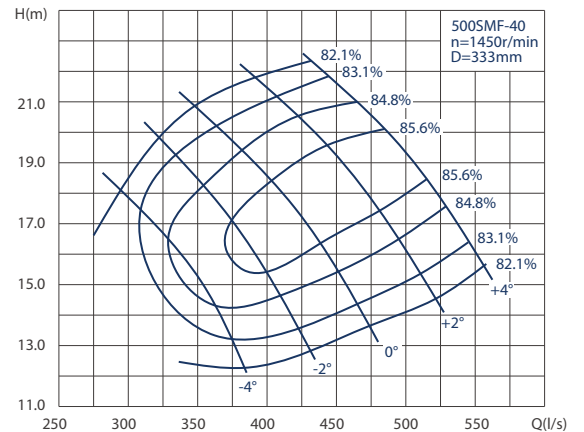



## 性能参数表及性能曲线

### Performance parameter and Performance curve

#### 500SMF-50

叶片安装角度 Installation angle	流量 Capacity		扬程 Head (m)	转速 Speed (r/min)	功率 Power (kW)		效率 Eff. (%)	叶轮直径 D(mm) Impeller diameter
	(m <sup>3</sup> /h)	(l/s)			轴功率 Shaft power	电机功率 Motor power		
-4°	1620	450	11.1	980	60.26	75	81.27	445
	1731	481	9.72		55.68		82.32	
	1948	541	6.36		44.22		76.28	
-2°	1854	515	11.4		69.56	90	82.75	
	1962	373	9.98		63.71		83.70	
	2171	603	6.64		51.27		76.57	
0°	2027	563	11.6		76.59	90	83.60	
	2146	596	10.2		71.21		83.70	
	2376	660	6.92		58.11		77.05	
+2°	2264	629	11.9		87.67	110	83.70	
	2394	665	10.6		82.57		83.70	
	2650	736	7.34		67.87		78.04	

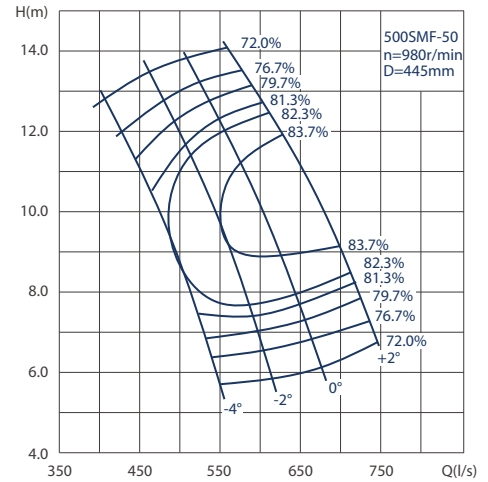

#### 500SMF-50A

叶片安装角度 Installation angle	流量 Capacity		扬程 Head (m)	转速 Speed (r/min)	功率 Power (kW)		效率 Eff. (%)	叶轮直径 D(mm) Impeller diameter
	(m <sup>3</sup> /h)	(l/s)			轴功率 Shaft power	电机功率 Motor power		
-4°	1620	450	10.2	980	55.56	75	81.0	445
	1800	500	8.00		47.59		82.4	
	1973	548	6.08		40.33		81.0	
-2°	1656	460	11.2		62.36	90	81.0	
	1951	542	9.00		57.07		83.8	
	2214	615	6.50		48.38		81.0	
0°	1800	500	11.9		72.02	90	81.0	
	2070	575	10.0		67.27		83.8	
	2412	670	6.70		54.33		81.0	
+2°	1926	535	12.2		79.02	90	81.0	
	2178	606	10.5		74.44		83.8	
	2563	712	7.00		60.32		81.0	

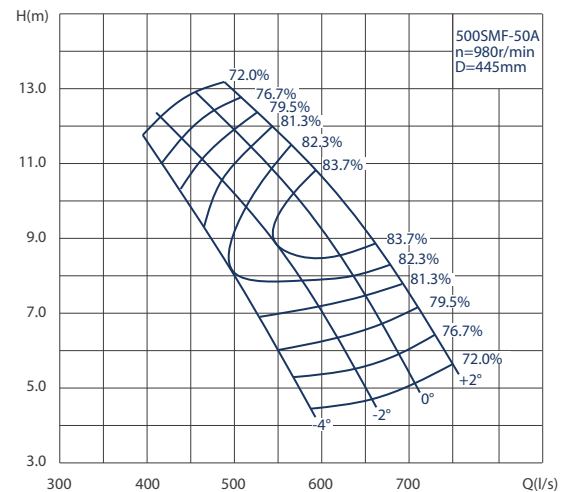

## 性能参数表及性能曲线

### Performance parameter and Performance curve

#### 600SMF-50

叶片安装角度 Installation angle	流量 Capacity		扬程 Head (m)	转速 Speed (r/min)	功率 Power (kW)		效率 Eff. (%)	叶轮直径 D(mm) Impeller diameter
	(m <sup>3</sup> /h)	(l/s)			轴功率 Shaft power	电机功率 Motor power		
-4°	1602	445	14.3	980	81.0	90	77.0	471
	2088	580	10.2		72.4		82.5	
	2304	640	7.42		60.5		77.0	
-2°	1710	475	15.2		92.0	110	77.0	
	2322	645	11.0		83.8		83.0	
	2574	751	7.5		68.3		77.0	
0°	1847	513	15.9		104.0	132	77.0	
	2459	683	12.0		95.8		83.9	
	2844	790	7.65		77.0		77.0	
+2°	2052	570	16.8		122.0	132	77.0	
	2808	780	12.0		109.4		83.9	
	3186	885	7.9		89.1		77.0	

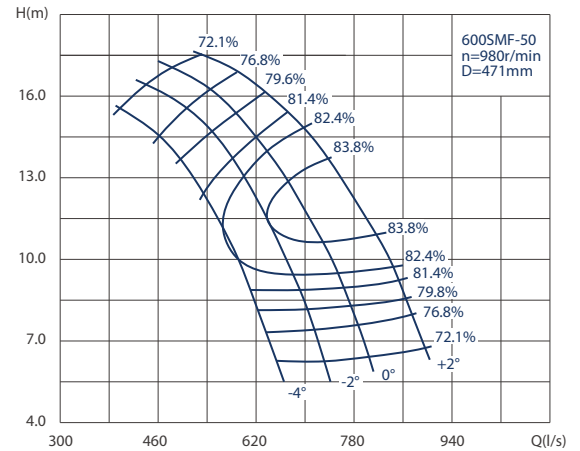

#### 600SMF-50A

叶片安装角度 Installation angle	流量 Capacity		扬程 Head (m)	转速 Speed (r/min)	功率 Power (kW)		效率 Eff. (%)	叶轮直径 D(mm) Impeller diameter
	(m <sup>3</sup> /h)	(l/s)			轴功率 Shaft power	电机功率 Motor power		
-4°	1602	445	12.9	980	73.09	90	77.0	471
	2106	585	9.00		62.57		82.5	
	2412	670	5.80		49.48		77.0	
-2°	1782	495	13.65		86.03	110	77.0	
	2322	645	10.0		75.37		83.9	
	2718	755	5.90		56.72		77.0	
0°	1926	535	14.2		96.73	132	77.0	
	2520	700	10.5		85.88		83.9	
	2952	820	5.25		54.80		77.0	
+2°	2027	575	14.7		105.40	132	77.0	
	2700	750	11.0		96.40		83.9	
	3118	880	6.70		73.90		77.0	

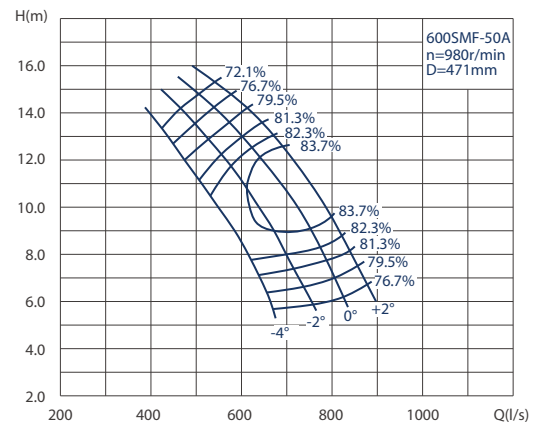

## 性能参数表及性能曲线

### Performance parameter and Performance curve

#### 700SMF-50

叶片安装角度 Installation angle	流量 Capacity		扬程 Head (m)	转速 Speed (r/min)	功率 Power (kW)		效率 Eff. (%)	叶轮直径 D(mm) Impeller diameter
	(m <sup>3</sup> /h)	(l/s)			轴功率 Shaft power	电机功率 Motor power		
-4°	2531	703	10.30	740	87.02	110	81.58	572
	2725	757	8.96		80.21		82.90	
	3060	850	5.89		63.89		76.82	
-2°	2902	806	10.60		101.03	132	82.91	
	3092	859	9.21		92.01		84.30	
	3420	950	6.16		73.90		77.64	
0°	3164	879	10.8		110.89	160	83.93	
	3366	935	9.42		102.43		84.30	
	3733	1037	6.42		82.77		78.96	
+2°	3535	982	11.1		126.77		84.30	
	3758	1044	9.74		118.26		84.30	
	4165	1157	6.81		98.02		78.81	

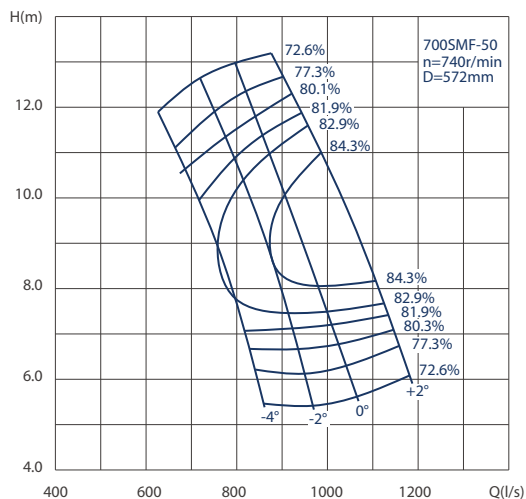

#### 700SMF-50A

叶片安装角度 Installation angle	流量 Capacity		扬程 Head (m)	转速 Speed (r/min)	功率 Power (kW)		效率 Eff. (%)	叶轮直径 D(mm) Impeller diameter
	(m <sup>3</sup> /h)	(l/s)			轴功率 Shaft power	电机功率 Motor power		
-4°	2124	590	10.5	740	75.92	90	80.0	572
	2794	776	7.30		66.91		83.0	
	3197	888	4.70		50.83		80.5	
-2°	2363	656	11.1		86.74	110	82.3	
	3078	855	8.20		81.34		84.5	
	3604	1001	4.80		58.88		80.0	
0°	2552	709	11.6		100.16	132	80.5	
	3341	928	8.60		92.60		84.5	
	3913	1087	5.10		67.10		81.0	
+2°	2747	763	12.0		111.93		80.2	
	3582	995	9.00		103.90		84.5	
	4201	1167	5.50		76.74		82.0	

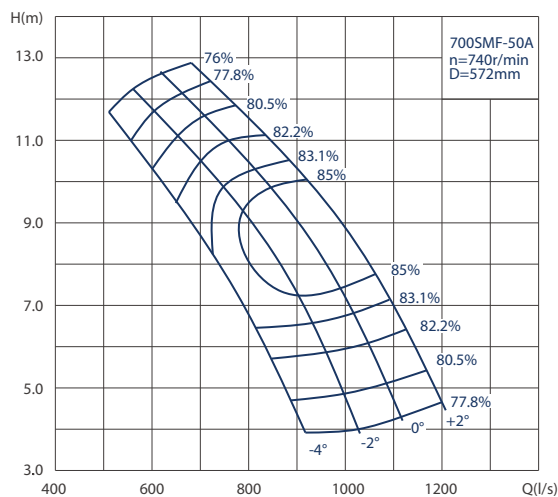

# 外形及安装尺寸 Outline and Installation Dimensions

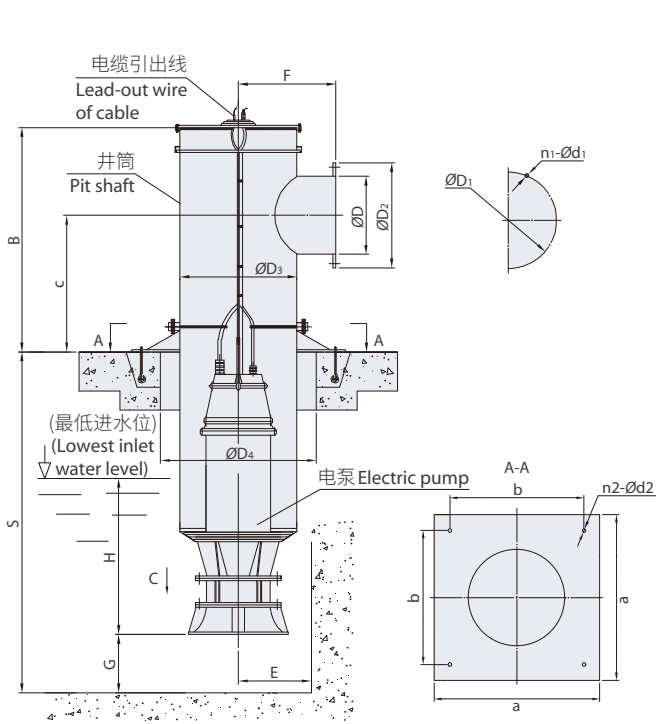

井筒安装外形尺寸(GT)  
Outline dimensions of pit shaft equipment(GT)

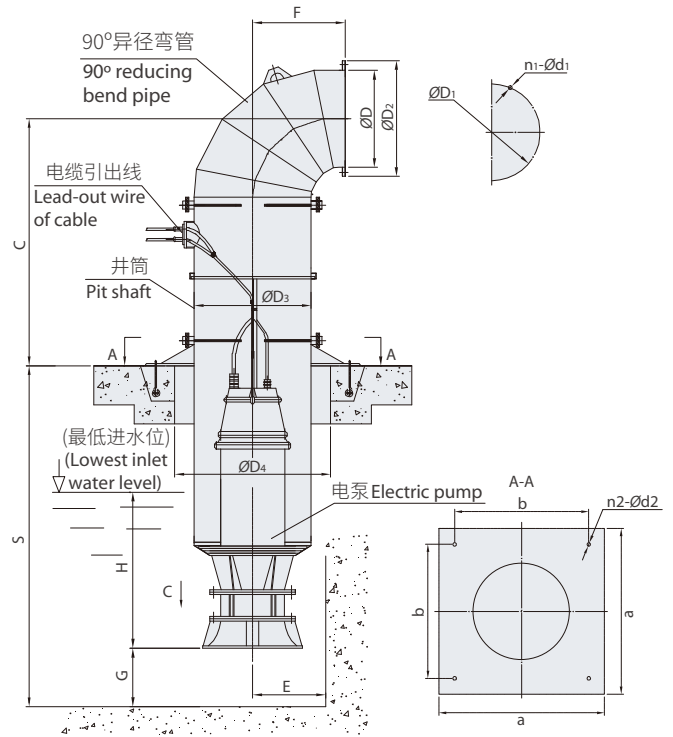

井筒弯管安装外形尺寸(GTW)  
Outline dimensions of pit shaft of bend pipe equipment(GTW)

## 外形及安装尺寸 Outline and Installation Dimensions

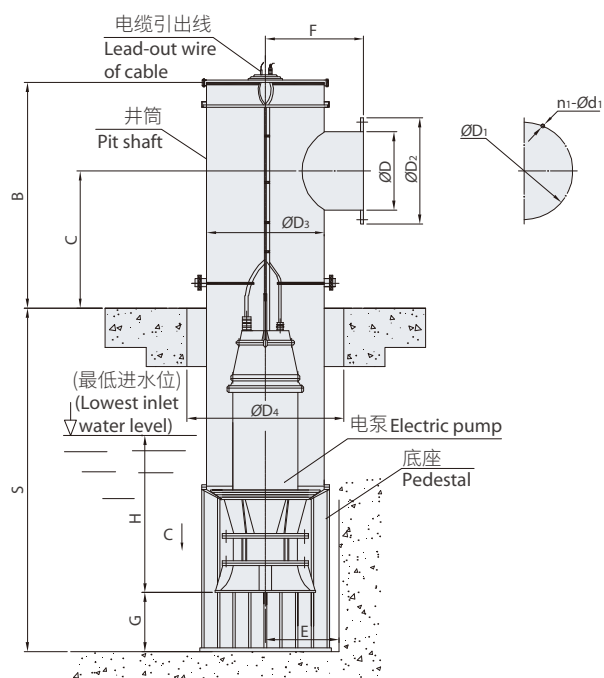

井筒落地安装外形尺寸(GD)

Outline dimensions of ground pit shaft equipment(GD)

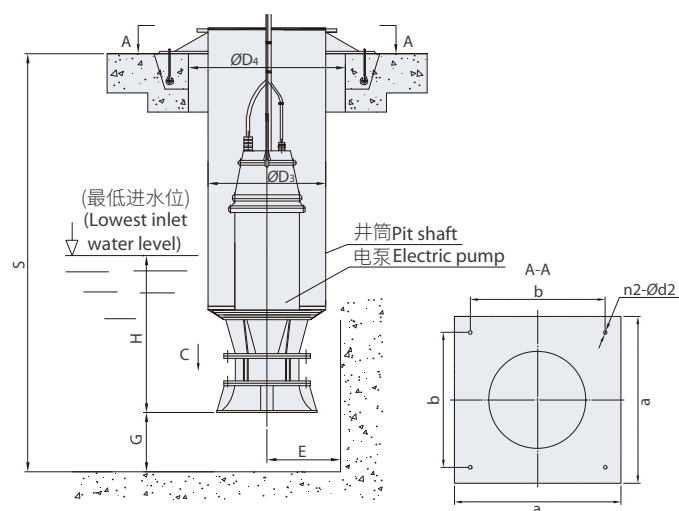

井筒敞开安装外形尺寸(GK)

Outline dimensions of open pit shaft equipment(GK)

注：1.ØD尺寸为我司标准出口口径，如客户有特殊要求，请与我司技术人员沟通。

1.ØD is GSD standard outlet diameter.If any special size required,please confirm with our technician in advance.

2.B、C、S尺寸根据现场土建确定。

2.B、C、S size shall follow civil construction request.



## 外形及安装尺寸表

## Outline and Sheet of Equipment Dimensions

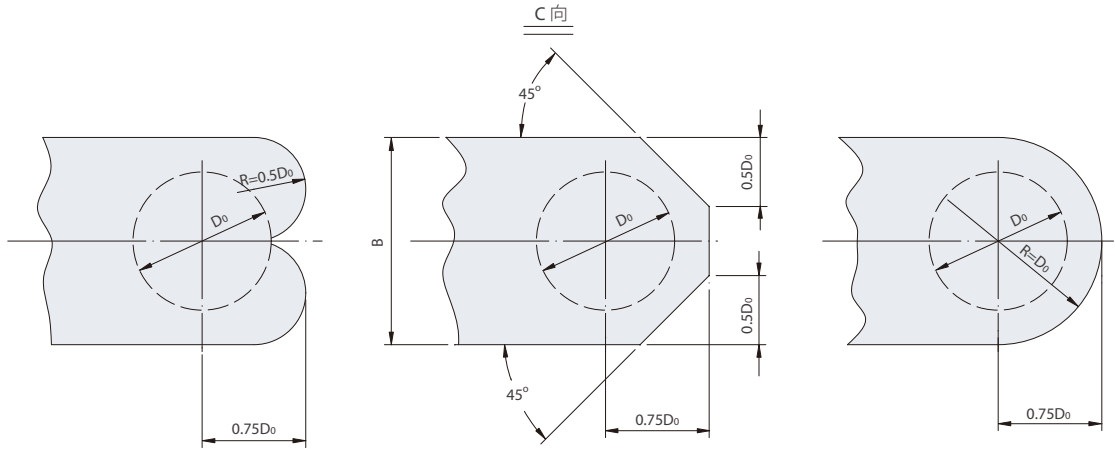

单位(Unit): mm

序号 No.	电泵型号 Pump type	H	D	D <sub>1</sub>	D <sub>2</sub>	n <sub>1</sub> -d <sub>1</sub>	D <sub>3</sub>	D <sub>4</sub>	E	F	G	a	b	n <sub>2</sub> -Ød <sub>2</sub>
1	300SAF	650	300	395	440	12-Ø22	530	700	350	450	300	1050	850	4-Ø18
2	350SAF	800	400	495	540	16-Ø22	610	800	400	500	350	1050	850	4-Ø18
3	500SAF	1000	600	705	755	20-Ø26	920	1200	600	650	450	1400	1200	4-Ø23
4	600SAF	1700	800	920	975	24-Ø30	1020	1300	650	700	550	1600	1400	4-Ø23
5	700SAF	1700	800	920	975	24-Ø30	1120	1500	750	800	600	1600	1400	4-Ø23
6	800SAF	1800	1000	1120	1175	28-Ø30	1220	1600	800	850	900	1800	1600	4-Ø33
7	400SMF	600	400	495	540	16-Ø22	610	800	400	500	350	1050	850	4-Ø23
8	500SMF	900	600	705	755	20-Ø26	920	1200	600	650	450	1400	1200	4-Ø23
9	600SMF	900	800	920	975	24-Ø30	1020	1300	650	700	550	1600	1400	4-Ø23
10	700SMF	900	800	920	975	24-Ø30	1120	1500	750	800	600	1600	1400	4-Ø23

# 轴、混流潜水电泵井筒式安装系统零部件 Spare parts of installation system of pit shaft type axial-flow and mixed-flow submersible electric pump

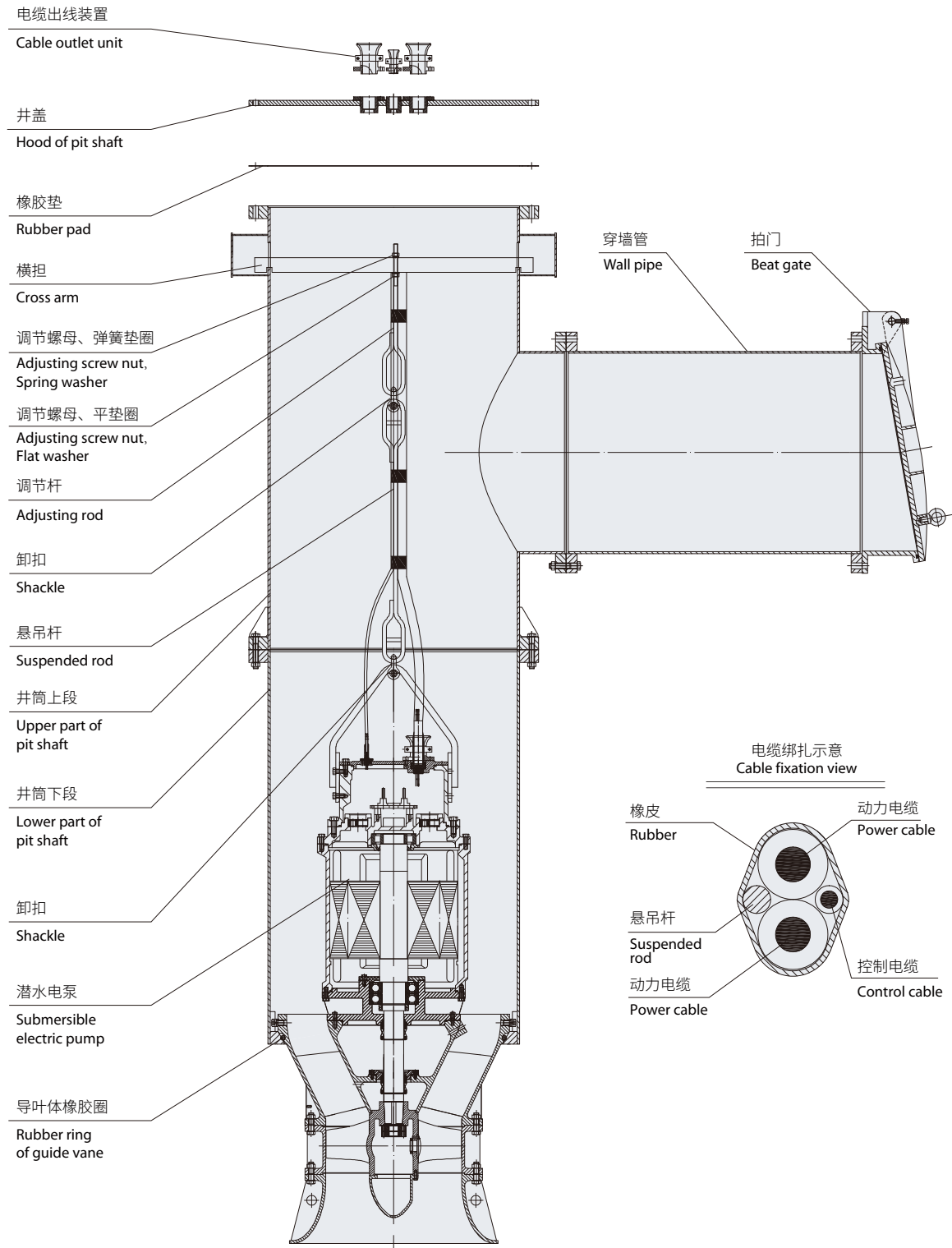

## 轴、混流潜水电泵及安装系统成套范围

### Complete set range of axial-flow,mixed-flow submersible electric pump and equipment system

序号 No.	名称 Name	安装形式 Installation formation				备注 Remarks
		井筒式 GT Pit shaft type GT	落地井筒式 GD Ground pit shaft type GD	弯道井筒式 GTW Bend pipe and pit shaft type GTW	开敞式 GK Open type GK	
1	轴、混流潜水电泵 Axial-flow,mixed-flow submersible electric pump	☆	☆	☆	☆	订货时注明泵型、流量、扬程、 电压、安装形式 Indicate pump type,flow rate,lift head, voltage and installation type when place an order.
2	电缆出线装置 Cable outlet unit	☆	☆	☆	○	
3	井盖 Hood of pit shaft Hood	☆	☆			
4	钢制井筒 Steel pit shaft	☆	☆	☆	☆	Q235A或SUS304 Q235A or SUS304
5	横担 Cross arm	☆	☆	☆	☆	
6	调节杆 Adjusting rod	☆	☆	☆	☆	
7	穿墙管 Wall pipe	○	○	○		Q235A或SUS304 Q235A or SUS304
8	异径弯管 Reducing bend pipe			☆		
9	悬吊杆 Suspended rod	☆	☆	☆	☆	
10	泵座 Pump base		☆			Q235A或SUS304 Q235A or SUS304
11	橡胶垫 Rubber pad	☆	☆	☆		
12	标准紧固件 Standard fastener	☆	☆	☆	☆	A2-70 A2-70
13	地脚螺栓 Foundation bolt	☆		☆	☆	
14	膨胀螺栓 Expansion bolt		☆			
15	抱箍 Holt hoop		☆			
16	拍门 Beat gate	○	○	○	○	
17	专用电控柜 Control cabinet	○	○	○	○	
18	动力电缆 Power cable	☆	☆	☆	☆	随机电缆长10米或订货时注明长度 Standard supply of electric cable is 10 meters long, or indicate length when place an order
19	控制电缆 Control cable	☆	☆	☆	☆	
20	水位控制器 Water-level controller	○	○	○	○	
21	机械密封 Mechanical seal	○	○	○	○	
22	导叶体橡胶圈 Rubber ring of guide vane	○	○	○	○	备品、备件订货时注明数量 Indicate the number of spare parts when place an order
23	轴承 Bearing	○	○	○	○	
24	专用工具 Special tool	○	○	○	○	

说明 Note:

☆为必购件，是采用该种安装形式所必备的零部件。

is the parts to be purchased parts,which are necessary for this type of installation formation.

○为选购件，由用户根据需要决定采购与否。

is the optional parts,which the user determines whether to buy or not and the quantity according to his requirement.





## 订货须知

- 订货时应注明潜水电泵的名称、型号规格、台数、安装方式、成套范围、起动方式、扬程、流量、功率、电压、水质条件、主要零部件材质，应注意选择的扬程是否包含泵装置全部水头损失的全扬程，如对全扬程估计不准，可注明扬程及安装方式向我公司咨询计算较准确的扬程，并确定潜水电泵的型号规格。
- 泵的最高扬程和最低扬程应参考样本的性能曲线和性能表。如有超过范围情况发生向我公司咨询。
- 在选择安装方式时，对钢制井筒安装方式推荐优先选用样本推荐的尺寸。如需改变表中的尺寸或选用其他安装方式的安装尺寸，请向我公司咨询。
- 订货时请注意样本成套范围。建议必购件应优先选用，选购件为推荐使用。
- 起动方式的选择可选择直接启动、Y- $\Delta$ 降压启动、自耦降压启动和软启动。本公司可提供各类起动柜、自动液位控制装置及泵站多泵逻辑顺序控制装置。
- 未注明特殊要求时电泵供电源的频率50HZ、380V。对频率60HZ和特殊电压的产品可在订货时商洽。









## Ordering instructions

- When placing an order, please give clear indication of name, type model, number, installation method, range in kit form, starting method, lift head, flow-rate, power, voltage, water quality condition, and material of main parts of the submersible electric pump. Attention should be paid if the chosen lifting head is the total head including all water head loss of pump equipment. If you can't estimate the total head correctly, please give clear indication of your lift head and installation direction to our company or consult our company for calculating more precise lift head so as to define specification and model of the submersible electric pump.
- Refer to the performance curve and performance table of catalogue for the highest and lowest lift head of pump. If the lift head is over the range, please consult our company.
- When you are selecting the installation mode, we recommend the dimensions in the catalogue for installation mode of steel pit shaft. If you want to change dimensions of sheet or select other dimensions of installation mode, please consult us.
- When placing an order, please notice complete set range of catalogue. We suggest giving priority to the necessary parts, and the optional parts are recommended to use.
- Starting mode should be direct starting, Y- $\Delta$  reducing starting, auto reduced-voltage starting and soft start. Our company provides various starting tank, automatic level control equipment and logic sequence controlling device of multiple pump in pump station.
- If there is no special requirement indicated, power frequency and voltage of electric pump is 50HZ, 380V. Please arrange with us for the product of 60HZ and special voltage when placing order.



欢迎索取以下产品型录

To find out more about following products, please visit [www.gsd.net.cn](http://www.gsd.net.cn)

	<b>泵系列</b> Pump Series	潜水泵系列   陆上泵系列   特种泵系列 Submersible pump series   On land pump series   Special pump series
	<b>搅拌推流系列</b> Mixing and flow propeller	搅拌机系列   推流器系列 Mixing series   Flow propeller series
	<b>供氧曝气系列</b> Aeration equipment series	曝气机系列   曝气盘系列   曝气管系列 Aerator series   Disc diffusers   Tube diffusers
	<b>风机系列</b> Blower Series	磁悬浮鼓风机   空气悬浮鼓风机   三叶罗茨鼓风机系列 Maglev turbo blower   Turbo blower   Three-lobe Roots Blower blower series
	<b>污泥处理设备</b> Sludge treatment equipment	带式脱水机   厢式压滤机   叠螺式脱水机   污泥干化设备   浅层高效气浮设备 Belt filter press   Box filter press   Screw press   Mud scraper   Dissolved air flotation clarifier
	<b>智能化系列</b> Intelligent series	智能设备   水务设备健康管理   水务系统工艺优化智联管理 Intelligent equipment   Health management for water equipment   Intelligent management for water system process
	<b>反应器及套装设备</b> Reactor and package equipment	芬顿反应系统   MBR生物膜反应器   预制泵站   一体化污水处理设备 Fenton reaction system   MBR biofilm reactor   Prefabricated pumping station   Intelligent Compact Unit
	<b>耗材药剂及相关设备</b> Consumables, reagents and related equipment	生物绳   PAC 聚合氯化铝   PAM 聚丙烯酰胺   泡药设备 Biological rope   PAC polyaluminum chloride   PAM polyacrylamide   Automatic dispensing dissolvers

GSD 的经营理念 Business Philosophy

G-Green 绿色 S-Safe 安全 D-Development 永续经营



川源(中国)机械有限公司  
GSD (China) Co., Ltd.

水处理系统专业合作伙伴

Professional partners in water treatment systems

免费咨询电话

400-657-9066

川源(中国)机械有限公司版权所有 all rights reserved. CY-48

数据来源: 公司实验室数据及客户实际使用数据, 具体使用环境不同, 数据可能存在差异。本型录内容如有变更, 恕不另行通知。

The data on the brochure is based on the laboratory testing data and customers' actual operation data in the past. The actual data may be different in different application conditions. We reserve the right to change content without notice.

